

AC 120-277V 
1-10V dimming

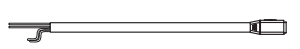

Starter cable, 3m/10ft





Interconnection Cable, 1m/3ft

Black, L	Live
White, N	Neutral
Violet, DIM+	1-10V+
Grey, DIM-	1-10V-

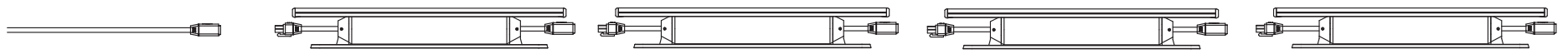
Max. daisy chain length (10ft starter cable)		
2.5W/ft	150ft @120V	300ft @277V
5W/ft	100ft @120V	200ft @277V
12W/ft	40ft @120V	100ft @277V



 <p><small>Please check for the latest updates and changes on the TRAXON website. ©2019 TRAXON TECHNOLOGIES - AN OSRAM BUSINESS. ALL RIGHTS RESERVED. WWW.TRAXONTECHNOLOGIES.COM</small></p>	TITLE:	SYSTEM WIRING DIAGRAM	DATE:	17 OCT 2019
	PRODUCTS:	COVE LIGHT AC DIM GII (ETL VERSION)	DWG. BY:	
			SCALE:	NOT TO SCALE
			PAGE:	1 OF 1

AC 120-277V 
1-10V dimming

Wiring Box (Starter cable inside)
(Starter cable sold separately)

Interconnection Cable, 1m/3ft

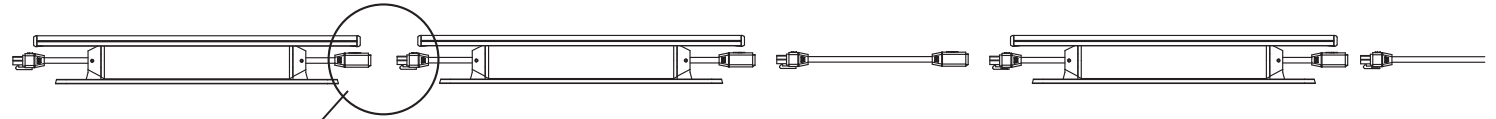
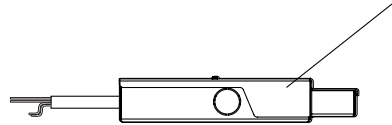

Starter cable, 3m/10ft

Black, L	Live
White, N	Neutral
Violet, DIM+	1-10V+
Grey, DIM-	1-10V-

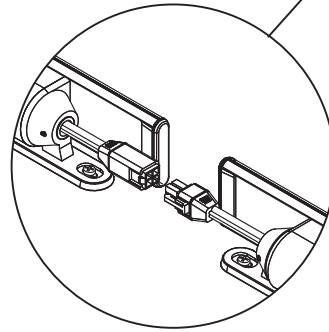

Max. daisy chain length (10ft starter cable)		
2.5W/ft	150ft @120V	300ft @277V
5W/ft	100ft @120V	200ft @277V
12W/ft	40ft @120V	100ft @277V

