

ecue



TRAXON | ecue
MEMBER OF PROSPERITY GROUP



AM390290035, AM394020035

SYMPL pixel Node & Pixel Range Extender Information for Use

Read the Information for Use and the Safety Instructions carefully. Subject to modification without prior notice.

Typographical and other errors do not justify any claim for damages. Modification of the product is prohibited.

This manual is designed for electricians, system administrators, and product users.

All product names and trademarks mentioned in this manual are trademarks of their respective owners.

Except for internal use, relinquishment of the instructions to a third party, duplication in any type or form - also extracts - as well as exploitation and / or communication of the contents is not permitted.

Downloads and more information at:
www.ecue.com

Edition:

06.07.23 [EN_SYMPL_pixel_Node_Setup_v2p0]

Published by:

Traxon Technologies Europe GmbH
Karl-Schurz-Strasse 38
33100 Paderborn, Germany

©2023 Traxon Technologies Europe GmbH
All rights reserved

Traxon Technologies Europe GmbH
Sales Operations
Karl-Schurz-Str. 38
33100 Paderborn, Germany
+49 5251 54648-0
support@ecue.com

Table of Contents

1	Safety instructions	03
1.1	Symbols	03
1.2	General safety instructions	03
2	General device description	03
2.1	Delivery content	04
2.2	Optional accessories	04
2.3	Product specifications	04
2.4	Connectors and interfaces	05
2.5	User interface: LEDs	05
2.6	Identify button: Identification & Reset & Testing	06
3	General remarks	06
3.1	Transport	06
3.2	Unpacking	06
3.3	Warranty regulations	07
3.4	Maintenance and Repair	07
3.5	Disposal	07
3.6	Support	07
4	Installation	08
4.1	Installation conditions	08
4.2	Mounting process	08
4.3	Ethernet connection	08
4.4	Pixel connection, e.g. SPI, DMX	09
4.5	Power supply	09
5	Wiring diagram	11
6	Pixel Range Extender	13
6.1	Wiring diagram with Pixel Range Extender	15
7	Network configuration	18
7.1	Default network properties	18
7.2	Network configuration with SYMPHOLIGHT	18
7.3	Network configuration with the web interface	18
8	Output configuration	20
8.1	LED protocol configuration via web interface	20
9	Test mode	21
10	Firmware Update	22
11	Dismounting	23
12	Certifications	23
13	Dimensions	24
13.1	SYMPL pixel Node	24
13.2	Pixel Range Extender	24
14	Supported Protocols	25
15	FAQ	26
15.1	About the SYMPL pixel Node	26
15.2	System	26
15.3	Power supply	27
15.4	Network	27
15.5	Protocols	28
15.6	Update	28
15.7	About the Pixel Range Extender	28

1 Safety instructions

Please read the safety instructions, provided in a separate manual, carefully. Make sure that the environmental, mounting, and installation prerequisites are met. This manual should be kept at a safe place and in reach of the device.

1.1 Symbols



The exclamation mark warns about possible damage of the device itself, to connected devices, and to the user.



The information symbol gives general hints and informs about handling and procedures for use of the device.

1.2 General safety instructions



- Connect cables and data only when the device is powered down.
- When using a power supply unit, the device must be supplied by a separate power supply that is certified according to the local regulations (e.g. SELV, Class 2).
- The Ethernet port of the SYMPL Node is not designed for inter-building connections with power and lighting transients. Use only intra-building networks to connect the SYMPL Nodes and Cores.



- If safety instructions are missing, please contact Traxon e:cue to receive a new copy.

2 General device description

e:cue SYMPL Nodes are a system of interfaces for e:cue SYMPHOLIGHT only. They provide various connection types like DMX512, DALI, digital inputs and outputs etc. SYMPL Nodes always operate in online mode, as a device interface for SYMPHOLIGHT. All interactions are initiated and controlled by SYMPHOLIGHT. Connections between servers, Cores and Nodes are always made with e:net via Ethernet.

The SYMPL pixel Node is a LED pixel controller, converting e:net to control a wide range of supported serial addressable LED pixels like digital LED strips, dots and boards with multi controllable pixel. Control a wide range of supported asynchronous and synchronous like SPI LED pixels and configure content with e:cue's SYMPHOLIGHT. It comes with 2 x Pixel outputs over screw terminal plugs. Choose the output protocol separately for each of the two outputs. The Node makes it possible to run up to 2 x 2048 channels (= 4096 in total, = 1364 RGB pixels) over Ethernet. Connection to the server runs via Ethernet interface with 100 Mbit/s. The Node is powered by an external power supply, Power-over-Ethernet, or a via pass back power from the connected fixture. It is easily mounted on standard 35 mm DIN rails, or with a key hole in the housing base on walls or on any stable vertical surface. Cover distances of up to 300 m* between the Node to the fixture with the optional Pixel Range Extender (page 13).



- To operate the SYMPL pixel Node a SYMPHOLIGHT version 5.1 or higher is mandatory. Earlier versions do not support the SYMPL pixel Node.

2.1 Delivery content

Delivery content for the e:cue SYMPL pixel Node (AM390290035):

1. e:cue SYMPL pixel Node
2. Safety instructions
3. Welcome note

2.2 Optional accessories

- 2 x Pixel Range Extender (AM394020035) for distances of up to 300 m*) between the Node and the fixtures. For installation information see „6 Pixel Range Extender“ on page 13.

*) depending on installation setup, cable quality, and fixture type

- Power Supply 15W 24V DIN rail (AM1884100HA)
- SYMPL Switch (AM313830035)

2.3 Product specifications

Dimensions (W x H x D)	53.5 x 90.5 x 62 mm (excl. fastening clip)
Weight	100 g
Power supply input	5 ... 24 V DC pass back power from Pixel Port 1 (e.g. from Pixel Strip) or 5 ... 24 V DC terminal plug cross cable section: 0.2 - 3.3 sqmm or PoE IEEE 802.3af on RJ45
Power consumption	2 W
Operating temperature	-20 ... 50 °C / -4 ... 122 °F
Storage temperature	-20 ... 70 °C / -4 ... 158 °F
Operating / storage humidity	0 ... 80% RH, non-condensing
Protection class	IP20
Installation	Indoor installation only, intra building connections only
Electrical safety class	SELV
Housing	Self extinguishing blend PC/ABS, UL E140692
Mounting	on 35 mm DIN rail (EN 60715), or with key hole on any stable vertical surface
Certificates	CE, ETL, RoHS, FCC, UKCA

Interface specifications

Output connectors	2 x serial addressable LED pixel output (4-pin terminal plug) cross cable section: 0.2 - 3.3 sqmm
Output channels	Up to 2048 pixel channels per output (= 682 RGB pixels) or up to 512 DMX channels per output (= 170 RGB pixels)



Output wiring	Cable length between controller and fixture up to 3 m (with Pixel Range Extender up to 300 m*)
Ethernet-Port	1 x ethernet 10/100 Mbit/s, RJ45 for e:net, PoE
User interfaces	LEDs for Ethernet activity, device status, output activity; Identify button; web interface

*) depending on installation setup, cable quality, and fixture type.

2.4 Connectors and interfaces

View from top:

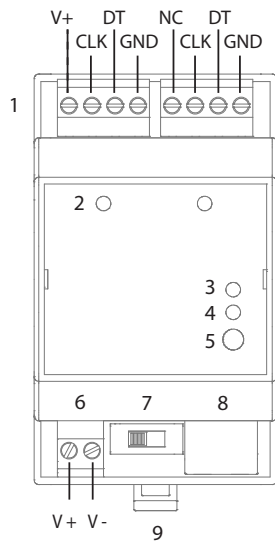

- 1 Pixel output 1 and 2 (V+ input, Clock 1, Data 1, Ground 1, Not Connected, Clock 2, Data 2, Ground 2, left to right)
- 2 Pixel output LEDs
- 3 Status LED (Device status)
- 4 Activity LED (Ethernet, LAN activity)
- 5 Identify button
- 6 Power supply (V+, V- left to right)
- 7 Power over Ethernet switch (OFF, ON left to right)
- 8 e:net / Ethernet
- 9 DIN rail handle

2.5 User interface: LEDs

The SYMPL pixel Node has four LEDs. The four LEDs show the basic states of the SYMPL Node.

LEDs

Status	<p>Green On: If constantly on, the device is online. Server application is in operation.</p> <p>Green blinking: If blinking in one second intervals, the device is offline, no connection to a SYMPHOLIGHT server or Core is available. If blinking more rapidly, the device is in bootloader mode.</p> <p>Red blinking: identifying the SYMPL Node (enabled "Identify Interface Mode" in SYMPHOLIGHT).</p> <p>Blue: Test mode.</p>
Activity	<p>Off: no link available.</p> <p>On: link established.</p> <p>Blinking: network traffic.</p>
Pixel 1 and 2	<p>Off: no LED pixel protocol (type) defined.</p> <p>Green: pre-configured asynchronous serial LED pixel protocols.</p> <p>Yellow: DMX512 protocol.</p> <p>Blue: pre-configured synchronous serial LED pixel protocols (except DMX).</p> <p>Magenta: custom protocols.</p>

2.6 Identify button: Identification & Reset & Testing

The Identify button has three functions: to send an Identify message (A), to reset the Node (B), and to test the installation (C)

(A) A short press during operation in online mode sends an Identify message to the server. This helps to assign the Node in the Layout in SYMPHOLIGHT.

(B) The Identify button can also be used to reset the device to factory state or to stay in bootloader mode:

- Keep the Identify button pressed while powering up, Status and Activity LEDs light up at first. Bootloader mode is signaled by a fast blinking Status LED. Release the button now. The device stays in bootloader mode to download a new firmware.
To exit the bootloader mode, short press the Identify button again.
- Press the Identify button until Status and Activity LEDs blink alternating, then blink together. Releasing the button now resets the device to its factory settings. The password and other settings are reset to their default values.
- Keeping the button pressed further on, the device proceeds to normal operation. No changes apply.

(C) Use the Identify button also to test the connected fixtures to ensure their correct installation.

- Access the Test mode of the SYMPL Node by fast double-pressing the Identify button during operation. The Status LED signals the Test mode with a blue color. The Test mode starts at the first pixel output with chasing lights (single run white, test pattern 1).
- Single-press the Identify button to switch between the following Test patterns:
 - All channels blink (pattern 2).
 - All channels at 100% (pattern 3).
 - All channels off (pattern 4).
 - Alternate between the individual pixel ports and the four test patterns. After the individual test of each pixel output, both pixel ports are tested simultaneously. Another short-press starts the test patterns from the beginning.
- Exit the Test mode any time by fast double-pressing the Identify button again. The device proceeds to normal operation.

-
- i
 - Note that testing via the Identify button always uses a block size of 3 channels (RGB → white). For LED fixtures with less or more than 3 channels, it is recommended to use the Test mode via web interface where you can define the block size (see „[Test mode via Web interface](#)“ on page 21).
 - Note that the Test mode outputs the configured protocol type only. See „[8 Output configuration](#)“ on page 20 for details.
-

3 General remarks

3.1 Transport

Only transport the device in its original packaging. This protects the device from damage.

3.2 Unpacking

Only unpack the e:cue SYMPL pixel Node at its installation location. To protect the device against condensation water, unpack it and wait until all moisture remaining in the device has evaporated.

Condensation can occur when the device is moved from a cold to a warm location. Keep the packaging for use in case of further transport. Inspect all parts for completeness regarding chapter „2.1 Delivery content“ on page 04. If there is apparent damage to the device or parts are missing from the delivery scope, please contact the Traxon e:cue Support service.

3.3 Warranty regulations

Depending on the product, warranty regulations are of different duration. The warranty time is usually noted in the quote and in the order confirmation. See www.traxon-ecue.com/terms-and-conditions for details. Legal warranty regulations apply in any case.

3.4 Maintenance and Repair

This device requires no maintenance.



- Before dismounting, appropriate measures must be taken to protect the respective components against damage caused by electrostatic discharge (ESD protection).
- Do not try to repair the device. Return it to your Traxon e:cue distributor for replacement or repair.

To update the firmware see „10 Firmware Update“ on page 22.

3.5 Disposal



Batteries and technical appliances must not be disposed of with domestic waste, but should be handed in at the appropriate collection and disposal points.

The proper disposal of packing materials and of the device is the responsibility of the respective user and for his account; in all other matters, the retrieval obligation for packing materials and the device is subject to the statutory regulations.

3.6 Support

In case of technical problems or questions regarding installation and repair please contact:

Traxon Technologis Europe GmbH
Customer Service
Karl-Schurz-Str. 38
33100 Paderborn, Germany
+49 (5251) 54648-0
support@ecue.com



4 Installation

-  – Connect cables and data only when the device is powered down.
- Each cable connected to the output ports should not exceed a length of 3 m. Use the range extender for cable length up to 300 m*.

The installation of the SYMPL pixel Node consists of mounting the device, connections to LED fixtures, to the network via Ethernet, and to power supply.

The sequence of cabling is not defined. Supply the SYMPL pixel Node with power after all cabling is completed; it starts booting.

4.1 Installation conditions

Installation position	Terminals on top and bottom
Horizontal spacing	No spacing necessary
Minimum vertical rail grid spacing	115 mm (90 + 25 mm) (excluding conduit)
Recommended vertical rail grid spacing	160 mm (with 40 mm conduit)
Installation location	Indoor

4.2 Mounting process

The e:cue SYMPL pixel Node is designed to mount onto a 35 mm DIN rail (EN 60715) in a vertical position.

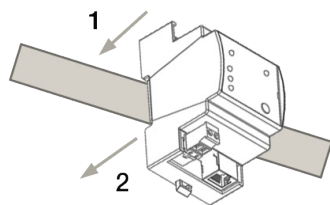

1. Clip the device to the rail from top.
2. Gentle pressure is then applied to the top front to snap it in place. The SYMPL pixel Node has been mounted successfully.

You can also mount the e:cue SYMPL pixel Node on any flat vertical surface. Use a 3 to 3.5 mm screw for the hanger hole.

For mechanical stability, mounting on a rail is recommended.

4.3 Ethernet connection

The following incoming DMX over Ethernet protocols are supported:

- e:net

-  – Never connect more than one SYMPL Node in factory state to a network. The identical IP addresses will conflict and disturb proper communication.
- The Ethernet port of the SYMPL Node is not designed for inter-building connections with power and lighting transients. Use only intra-building networks to connect the SYMPL Nodes and Cores.

The pin-assignment of the Ethernet port corresponds to RJ45 standards. You can use every common

Ethernet component, like cable, splitters, and switches. Connect the SYMPL pixel Node at the designated Ethernet interface with a patch cable (RJ45, CAT5).

4.4 Pixel connection, e.g. SPI, DMX



Use shielded and twisted pair cabling for data connections, like Cat 5e S*TP.

The SYMPL pixel Node can control two 2048-channel-universes (=4096 channels in total, = 1364 RGB pixels) with its two Pixel output ports.

You can have two different LED pixel protocol types connected at the same time on the two output ports, e.g. SPI on port 1 and DMX on port 2. For the supported output protocols see „14 Supported Protocols“ on page 25.

Connect two LED fixtures to the SYMPL Node using the two 4-pin terminal plugs at the pixel interface of the SYMPL Node.

The appropriate pin assignment is defined as follows, from left to right:

Pixel output 1: V+ input (5 ... 24 V DC), Clock 1, Data 1, Ground 1

Pixel output 2: not connected, Clock 2, Data 2, Ground 2

Special cases:

- DMX LED fixture: Connect “+” to “Clock”, “-” to “Data”, and “GND” to “GND” (fixture to Node).
- Pixel Range Extender for distances > 3m between the Node and the asynchronous LED fixture: Connect “Clock” to “Data +”, “Data” to “Data -”, and “GND” to “GND” (SYMPL pixel Node to Pixel Range Extender).

4.5 Power supply

The e:cue SYMPL pixel Node can be powered via pass back power from the LED fixture, via Power-over-Ethernet (PoE), or by an external power supply (PSU).



When using pass back power or an external power supply unit: The SYMPL pixel Node is not suited for powering over a DC power supply network. For supplying 24 V DC to the SYMPL pixel Nodes, the device must be supplied by a separate power supply that is certified according to the local regulations (e.g. SELV, Class 2).

Pass back power from LED fixture:

Set the PoE switch to “OFF” and connect V+ (5 ... 24 V DC) from the LED fixture on output port 1.

Ensure that at least 4.5 V (min) supply reach the Node at all times, especially at full LED load condition and when powering with 5 V. Check for voltage drop.

When placing the PSU between the Node and the fixtures (parallel connection), use a 24 V DC power supply unit that is certified according to the local regulations (e.g. SELV, Class 2).

PoE:

Set the PoE switch to “ON”. Connect an Ethernet connection from a power sourcing device.



Use a power supply for the connected luminaires that does not connect to the luminaires of other SYMPL pixel Nodes.



External power supply:

Set the PoE switch to “OFF”.

Connect the SYMPL pixel Node to a 24 V DC power supply unit that is certified according to the local regulations (e.g. SELV, Class 2). Present power supply equates to the status “On” or running of the SYMPL Node.

To connect the device to a power supply unit, use the provided 2-pole terminal and lay the wires as stated on the front label. The voltage assignment is left V+ and right V-.

Turn the power on when all cables are connected to the SYMPL pixel Node. The device starts booting. The device has finished booting and is in operation when the Status LED is flashing.

-
- i** – The default setting of the PoE switch is “OFF”. “OFF” is to be maintained except where stated otherwise. When PoE is not in use, keep the switch off.
 - For power supply scenarios see [„5 Wiring diagram“ on page 11.](#)
 - The SYMPL pixel Node is not suited to power connected LED fixtures.
 - It is recommended to use pass back power from the LED fixture’s PSU.
-



5 Wiring diagram

Power supply scenarios

Legende

	Vcc
	Clock
	Data
	Ground

PSU between Node and fixture, parallel connection - recommended wiring

Option A: One PSU supplies both fixtures and the Node via port 1 with power (+ pin, 5 .. 24 V DC). Have PoE switched OFF.

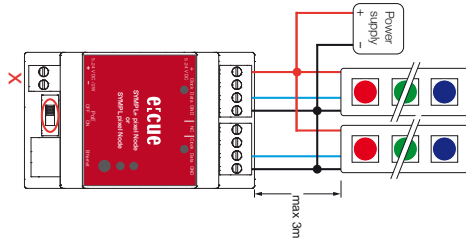

Option B: Each fixture has a separate PSU. The PSU for the fixture on port 1 also supplies the Node with power (+ pin, 5 .. 24 V DC). Have PoE switched OFF.

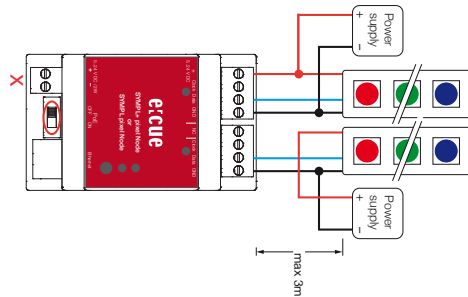

PSU behind fixture: Each fixture has a separate PSU, connected to the fixture only.

Opt A: The fixture on port 1 also supplies the Node with power (+ pin, 5 .. 24 V DC). Have PoE switched OFF. Ensure that at least 4.5 V (min) supply reach the Node at all times, especially at full LED load condition and when powering with 5 V. Check for voltage drop.

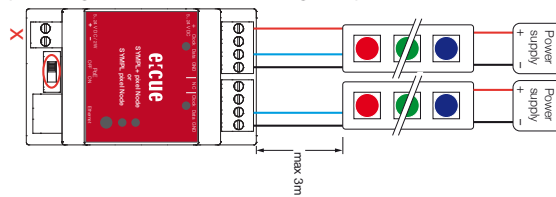

Opt B: The Node is supplied via PoE with power. Have PoE switched ON.

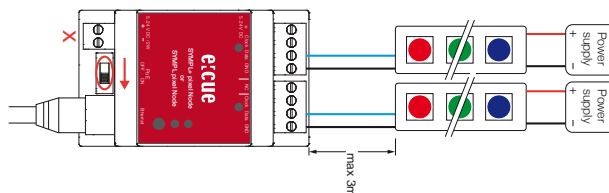

Opt C: The Node is supplied by its own PSU (5 .. 24 V DC) with power. Have PoE switched OFF.

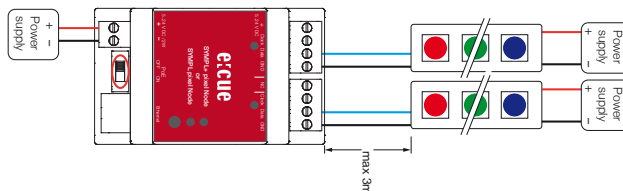

Wrong wiring

A: The Node cannot supply power to the fixture, neither with PoE, nor with its PSU.

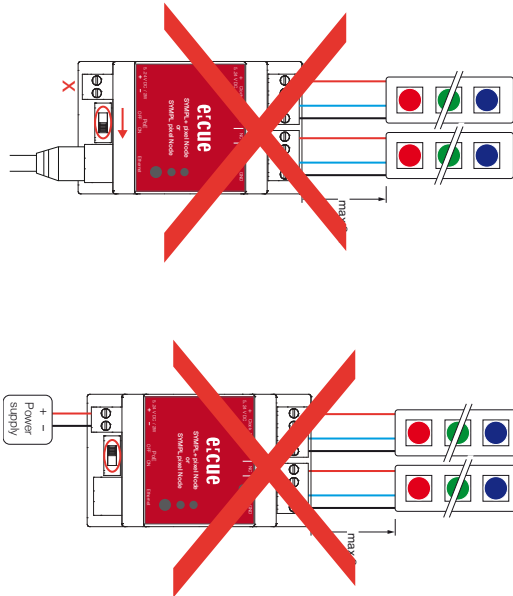

B: 2 or more Nodes cannot be powered via PoE from the same PoE switch and have their GNDs at the output connector simultaneously connected to the power supply of the fixtures.

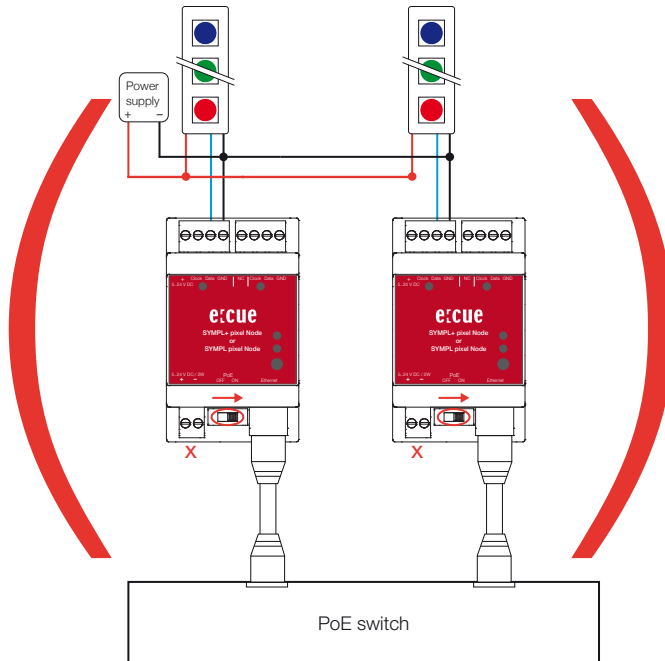

6 Pixel Range Extender



AM394020035

The Pixel Range Extender is an optional distance enlarger for one output of a Pixel Node. It is designed for bridging long distances between a Pixel Node controller and the LED fixture. Add the Pixel Range Extender in front of your fixture and you can cover distances of up to 300 m* to the controlling Node.

- i** For the Pixel Range Extender to work, you need to set the SYMPL pixel Node's output mode to "extender mode" (see [„8.1 LED protocol configuration via web interface“ on page 20](#)).

View from top:

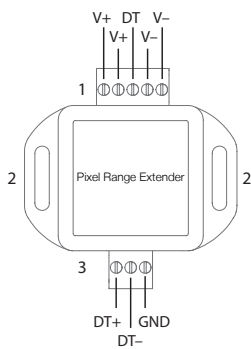

- 1 Fixture & Power interface (5 pins: +, +, Data, -, -, left to right)
- 2 Slotted hole
- 3 Controller interface (3 pins: Data +, Data -, Ground, left to right)



- Use shielded and twisted pair cabling for data connections, like Cat 5e S*TP.
- Use only intra-building networks. All ports of the Pixel Range Extender are not designed for inter-building connections.

Mount the Pixel Range Extender with two slotted holes on walls or on any stable surface.

Connect the "Controller" interface of the Pixel Range Extender to the Pixel interface of a SYMPL pixel Node: Connect "Data +" to "Clock", "Data -" to "Data", and "GND" to "GND" (Pixel Range Extender to SYMPL pixel Node).

On the "Fixture & Power" interface connect the Pixel Range Extender to the LED fixture using pins "+", "Data", and "-", and to the fixture's PSU.

For connection schemes see [„6.1 Wiring diagram with Pixel Range Extender“ on page 15](#).

Product specifications

Dimensions (W x H x D)	51.3 x 53.1 x 20 mm (incl. plug connectors)
Weight	20 g / 0.04 lb
Power supply input	Pass back power from fixture terminal (e.g. from Pixel Strip): 5 ... 24 V DC cross cable section: 0.2 - 3.3 sqmm
Power feedthrough	10 A max.
Power consumption	0.3 W (@ 24 V)
Operating temperature	-30 ... 50 °C / -22 ... 122 °F
Storage temperature	-40 ... 70 °C / -40 ... 158 °F
Operating / storage humidity	0 ... 80% RH, non-condensing
Protection class	IP20
Installation	Indoor installation only; intra building connections only; restricted to commercial, industrial, or business environment (FCC Class A)
Electrical safety class	SELV
Housing	General purpose ABS, UL 94-HB
Mounting	With slotted holes on any stable surface
Certificates	CE, ETL, RoHS, FCC, UKCA
Number of units	2

Interface specifications

Output connector	1 x serial addressable LED pixel output and power supply (5-pin terminal plug) cross cable section: 0.2 - 3.3 sqmm
Output wiring	Cable length between Pixel Range Extender and fixture up to 3 m
Input connector	1 x output of SYMPL pixel Node (3-pin terminal plug) cross cable section: 0.2 - 3.3 sqmm
Input wiring	Cable length between SYMPL pixel Node and Pixel Range Extender up to 300 m* (Cat 5e recommended)
User interfaces	LEDs for activity, device power

*) depending on installation setup, cable quality, and fixture type





Conforms to ANSI/UL Std. 62368-1
 Certified to CSA Std. C22.2 NO. 62368-1



This device complies with part 15 of the FCC Rules. Operation is subject to the following two conditions: (1) This device may not cause harmful interference, and (2) this device must accept any interference received, including interference that may cause undesired operation.

This equipment has been tested and found to comply with the limits for a Class A digital device, pursuant to part 15 of the FCC Rules.

These limits are designed to provide reasonable protection against harmful interference when the equipment is operated in a commercial environment. This equipment generates, uses, and can radiate radio frequency energy and, if not installed and used in accordance with the instruction manual, may cause harmful interference to radio communications. Operation of this equipment in a residential area is likely to cause harmful interference in which case the user will be required to correct the interference at his own expense.

6.1 Wiring diagram with Pixel Range Extender

Pixel Range Extender = PRE

Legende

	Vcc
	Clock
	Data
	Ground

PSU between PRE and fixture: Each fixture has a separate PSU. The PSU for the fixture also supplies the fixture's PRE with power (+ and - pins, 5 .. 24 V DC). The Node is supplied via PoE with power. Have PoE switched ON.

Opt A - recommended wiring: The PSU for the fixture supplies the fixture's PRE with power via separate wires to the PRE (all 5 pins in use).

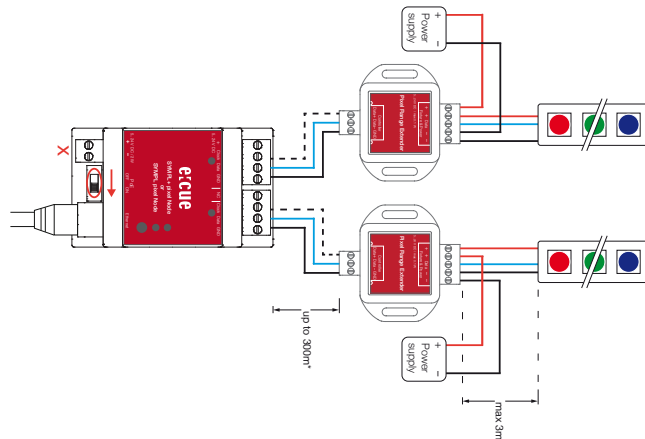

Opt B: The PSU for the fixture supplies the fixture's PRE with power via parallel connection (3 pins in use).

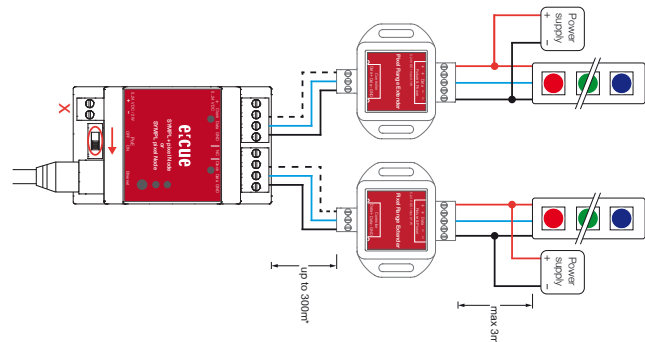

PSU between PRE and fixture: Each fixture has a separate PSU. The PSU for the fixture also supplies the fixture's PRE with power (+ and - pins, 5 .. 24 V DC). The Node is supplied by its own PSU (5 .. 24 V DC) with power. Have PoE switched OFF.

Opt A: The PSU for the fixture supplies the fixture's PRE with power via parallel connection (3 pins in use).

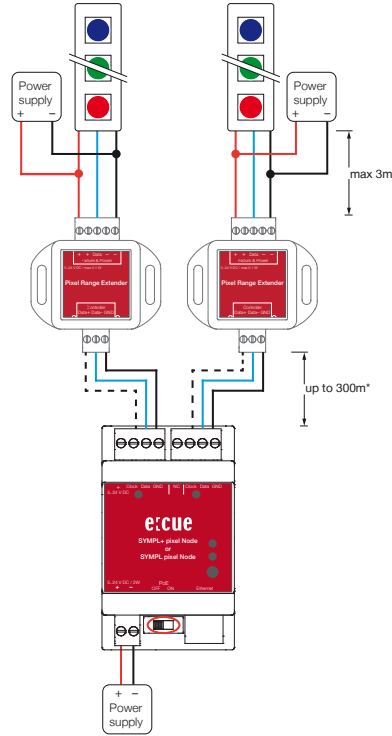

Opt B: The PSU for the fixture supplies the fixture's PRE with power via separate wires to the PRE (all 5 pins in use).

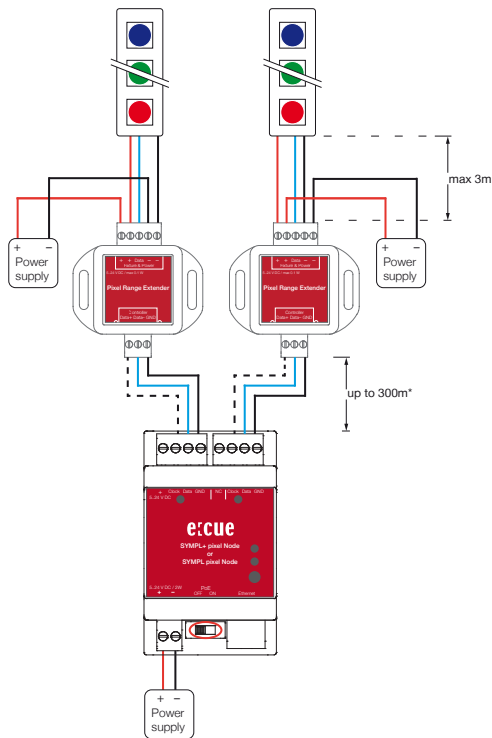

PSU behind fixture: Each fixture has a separate PSU, connected to the fixture. The PSU for the fixture also supplies the fixture's PRE with power (5 .. 24 V DC). Ensure that at least 4 V (min) supply reach the Pixel Range Extender at full fixture load, especially when using 5 V. Check for voltage drop.

Opt A: The Node is supplied with power via PoE. Have PoE switched ON.

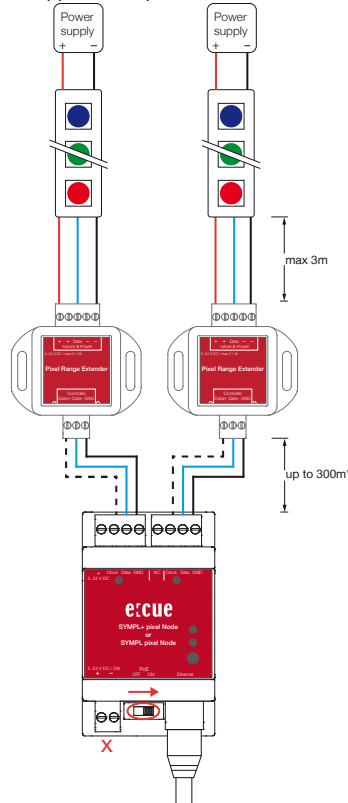

Opt B: The Node is supplied with power by its own PSU (5 .. 24 V DC). Have PoE switched OFF.

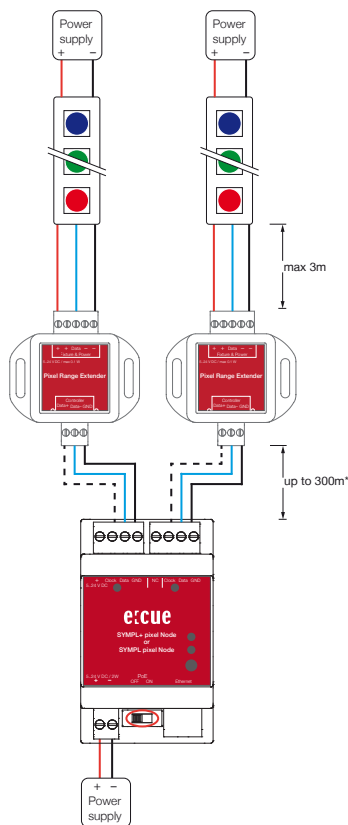

7 Network configuration

The network properties of the device are pre-configured. The successful installation of the power supply is required for changing the network configuration. You can either adjust the network settings using SYMPHOLIGHT or the web interface of the device.

7.1 Default network properties

The SYMPL pixel Node has as factory setting the default IP address 192.168.123.1.
 Subnet mask: 255.255.255.0.
 DHCP is enabled by default.

Login credentials for the web interface of the SYMPL pixel Node:

The default password is: **ecue**

To change the network configuration use either SYMPHOLIGHT or the web interface of the SYMPL pixel Node:

7.2 Network configuration with SYMPHOLIGHT

1. Open the context menu of the SYMPL pixel Node in the Setup tab of SYMPHOLIGHT by a right-click on the device.

2. Select "Configure Network":

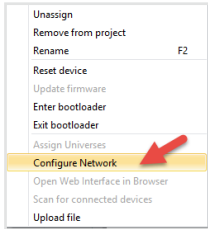

3. Define the IP address, the subnet mask and the DHCP settings to your needs:

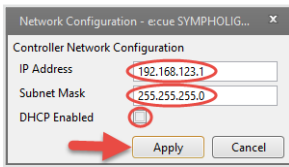

4. Click "Apply" to submit the changes.

The network configuration of the SYMPL pixel Node is completed.

7.3 Network configuration with the web interface

1. Open a common web browser on a connected PC. Enter the SYMPL pixel Node's IP address into the address bar:

e.g. <http://192.168.123.1>



The web interface of the SYMPL pixel Node is displayed:

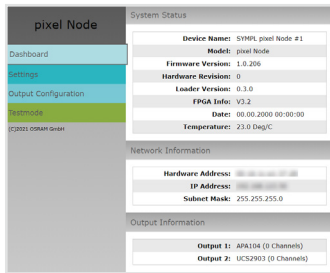

2. On the left side, select “Settings” and enter the default password **ecue**:

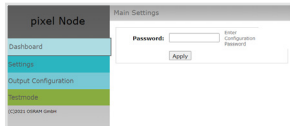

3. Click “Apply”. The Settings page is displayed:

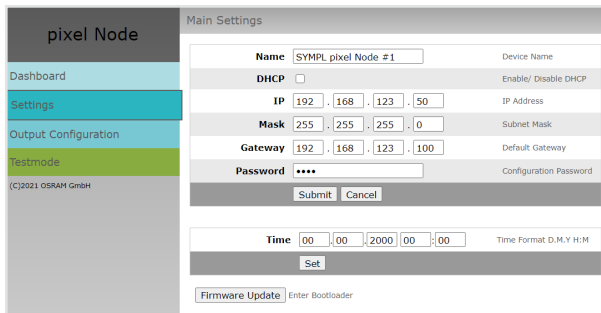

4. Define the network settings to your needs. You can also change the password for entry to the web interfaces of the SYMPL pixel Node here.

5. Click “Submit” to apply the settings.

The network configuration of the SYMPL pixel Node is completed.

- i

 – The employment of a discrete network is recommended.
- Note down all employed and, if applicable, reserved IP addresses. Keep the information for future network configurations.
- You can change the login password to the SYMPL pixel Node's configuration page and the device name of the SYMPL pixel Node at “Settings” page. Do not forget the new password.

8 Output configuration

The SYMPL pixel Node offers a variety of supported output protocols - see „14 Supported Protocols“ on page 25 and for an updated list with all supplemented protocols www.ecue.com. Each of the two pixel output ports can be configured individually and independent from each other.

The settings of the output protocols is configured via the web interface.

8.1 LED protocol configuration via web interface

1. Open the output configuration page by selecting it on the left side of the web interface of the SYMPL pixel Node:

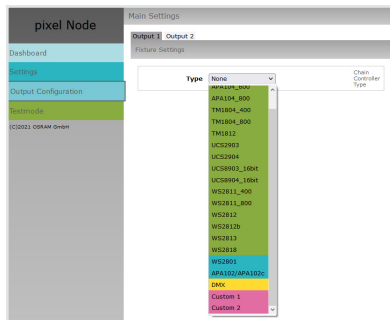

2. Click an output and select a supported protocol at “Type”. You can also define two custom types. Define the properties where necessary:

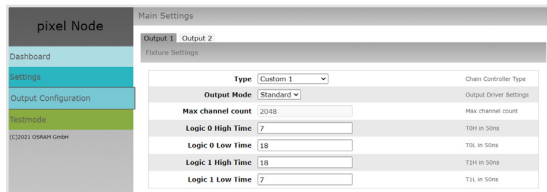

Property	Description
Output Mode	Select whether you use a Pixel Range Extender: Extender, or not: Standard. - for asynchronous protocols only -
Max channel count	Total theoretical frame length. Actual size is defined by the Universe settings in SYMPHOLIGHT. Does not represent the number of connected channels.
Logic 0 High Time	TOH in 50 ns.
Logic 0 Low Time	TOL in 50 ns.
Logic 1 High Time	T1H in 50 ns.
Logic 1 Low Time	T1L in 50 ns.

- i** – For the Pixel Range Extender, set the Output Mode to differential.
- Type APA104:
Configure the universe length in SYMPHOLIGHT to a maximum of 1024 channels.
If output discrepancies occur, switch between the two APA104 types (APA104_400Hz and APA104_800Hz).

The settings are immediately effective.

9 Test mode

The SYMPL pixel Node provides a Test mode for the connected LED fixtures. There are two kinds: using the Identify button and using the web interface of the SYMPL pixel Node. The Test mode is indicated by the blinking Status LED.

Please note that the Test mode overwrites all other DMX output like running projects for the time of testing. A running show is reverted to after exiting the Test mode.

Test mode via Identify button

See section (C) on page 06 at “2.6 Identify button: Identification & Reset & Testing”.

Test mode via Web interface

The web interface of the SYMPL pixel Node provides three different test patterns and allows to change their properties.

Open the Test mode page by selecting “TestMode” on the left side of the web interface of the SYMPL pixel Node:

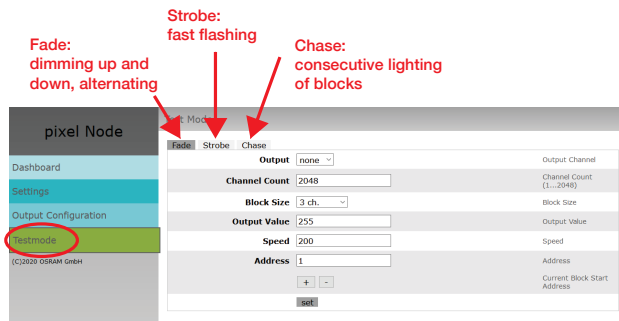

Click a button to choose a test pattern. Define the properties:

Property	Description
Output	Pixel output ports to run the test on.
Channel Count	Total frame length.
Block Size	Block size in which to step through the frame length in channel count.
Offset	Start address of the first test loop (first channel = 1).
Output Value	Luminance of the test output (0 - 255).
Speed	Speed of the illumination (0 - 500). Chase: For manual address stepping set to 0.
Address	The start address of the test output.
Revert	Enable to revert the direction of the chase light.

Click “set” to run the test and to apply changes in the test settings.

Exit the Test mode by leaving the Test mode page, e.g. go to “Dashboard”, or by double-pressing the Identify button.

10 Firmware Update

In case a new firmware version is available, you can either use SYMPHOLIGHT or the web interface of the SYMPL pixel Node to update the device.

i It is recommended to use SYMPHOLIGHT.

Updating with SYMPHOLIGHT

Use the usual update options in the Devices window of the Setup tab in SYMPHOLIGHT: select “Update firmware” in the context menu of the SYMPL pixel Node.

If you have a separate file for a specific firmware version that is not included in SYMPHOLIGHT, you need to manually update the Node using the “upload file” option in the context menu.

Updating with web interface

1. Save the new firmware file from www.ecue.com.
2. To access the web interface, open a common web browser on a connected PC. Enter the SYMPL pixel Node's IP address into the address bar: e.g. <http://192.168.123.1>.
3. On the left side, select “Settings” and click the “Firmware update” button at the end of the page:

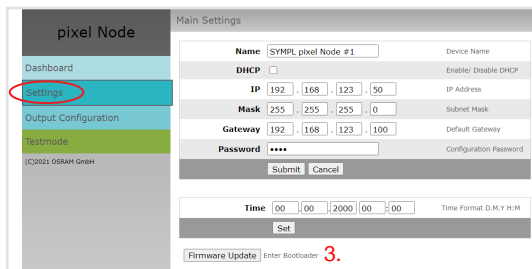

The device enters the bootloader mode and the firmware loader window is displayed:

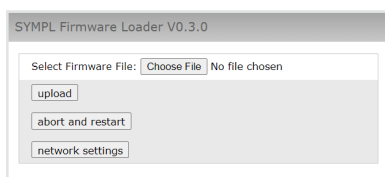

4. Browse for the new firmware file and click “upload” to start the updating process. Wait until the process has finished to get back to normal operation. Acknowledge the firmware version and the Dashboard page appears. In case the Dashboard is not displayed, please reload the browser tab.

The firmware update is completed.

To abort the firmware update, click “abort and restart”. Wait for the device to reboot.

11 Dismounting



Before dismounting, appropriate measures must be taken to protect the respective components against damage caused by electrostatic discharge (ESD protection).

Disconnect all attached cables. Dismount the e:cue SYMPL pixel Node from the rail by pulling the black DIN rail handle and unhitching the SYMPL pixel Node. The dismounting is completed.

12 Certifications



Conforms to ANSI/UL Std. 62368-1
 Certified to CSA Std. C22.2 NO. 62368-1



This device complies with part 15 of the FCC Rules. Operation is subject to the following two conditions: (1) This device may not cause harmful interference, and (2) this device must accept any interference received, including interference that may cause undesired operation.

This equipment has been tested and found to comply with the limits for a Class B digital device, pursuant to part 15 of the FCC Rules.

These limits are designed to provide reasonable protection against harmful interference in a residential installation. This equipment generates, uses and can radiate radio frequency energy and, if not installed and used in accordance with the instructions, may cause harmful interference to radio communications.

However, there is no guarantee that interference will not occur in a particular installation. If this equipment does cause harmful interference to radio or television reception, which can be determined by turning the equipment off and on, the user is encouraged to try to correct the interference by one or more of the following measures:

- Reorient or relocate the receiving antenna.
- Increase the separation between the equipment and receiver.
- Connect the equipment into an outlet on a circuit different from that to which the receiver is connected.
- Consult the dealer or an experienced radio/TV technician for help.



13 Dimensions

All dimensions in mm

13.1 SYMPL pixel Node

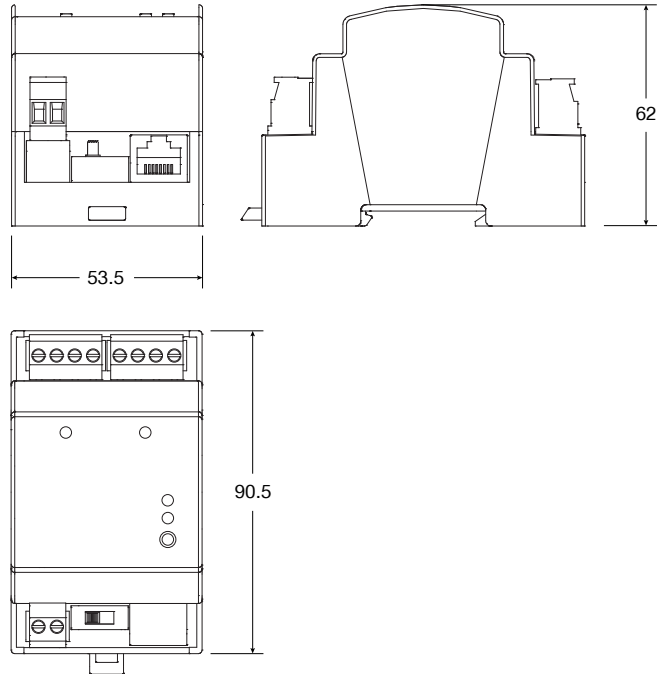

13.2 Pixel Range Extender

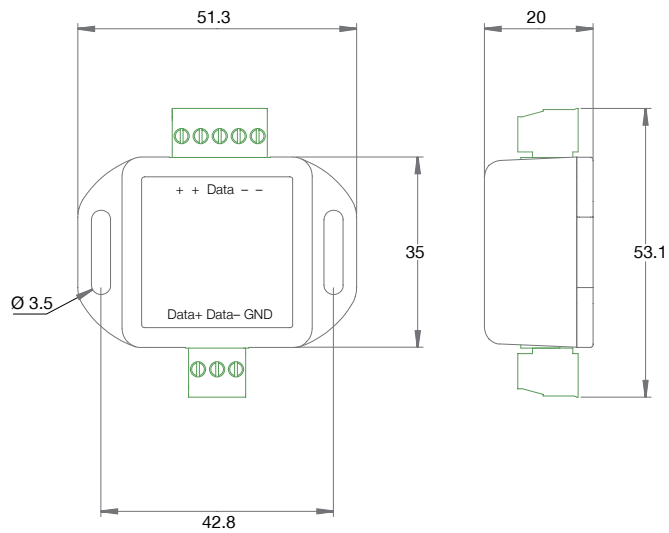

14 Supported Protocols

- For the Pixel Range Extender to work, you need to set the SYMPL pixel Node's output mode to "extender mode" (see [„8.1 LED protocol configuration via web interface“ on page 20](#)).
- For an updated list with all supplemented protocols see the SYMPL pixel Node page on www.ecue.com.

Communication protocols (input):

- e:net

LED pixel protocols (output) extendable by Pixel Range Extender:

asynchronous (1-wire):

- TM1804_400
- TM1804_800
- TM1812
- APA104_400
- APA104_800
- UCS2903
- UCS2904
- UCS8903_16bit
- UCS8904_16bit
- WS2811_400
- WS2811_800
- WS2812
- WS2812b
- WS2813
- WS2818

LED pixel protocols (output) not extendable by Pixel Range Extender:

- DMX512

synchronous (2-wire):

- APA102 / APA102c
- WS2801



15 FAQ

15.1 About the SYMPL pixel Node

Can you run strips and dots at the same time?

Yes, each LED pixel output can be set to different protocols. And as long as they have the same protocol on the same port, multiple LED devices can be controlled simultaneously by the SYMPL pixel Node - up to 2048 channels per output port.

Does the device support DMX?

Yes. The SYMPL pixel Node supports DMX. Simply connect the DMX device to one LED pixel output and set the output protocol to "DMX".

Does the device support RDM?

No. The SYMPL pixel Node supports one-directional communication only.

What do the blinking LEDs on the device and their colors mean?

The LEDs indicate the basic states of the SYMPL pixel Node. See [„2.5 User interface: LEDs“ on page 05](#).

Can I test my installation?

Check whether your installation with its wiring and configuration is correct by using one of the two test options that come along with the SYMPL pixel Node: the Test mode in the web interface or directly on the device via the Identify button. For the Test mode, see [„9 Test mode“ on page 21](#), for the test using the Identify button [„2.6 Identify button: Identification & Reset & Testing“ on page 06](#).

Can I repair the device myself?

No. Do not try to repair the device. Return it to your Traxon e:cue distributor for replacement or repair.

What can I do if my device does not work anymore?

Please contact your supplier in case of malfunctioning.

Where can I get help or send feedback?

In case of technical problems or questions regarding installation and repair please contact the customer service (see [„3.6 Support“ on page 07](#)). Any other feedback is also more than welcome!

15.2 System

Do I need a SYMPHOLIGHT license/ dongle?

Yes. To control the pixels, you need a SYMPHOLIGHT license.

Is it possible to use more than one SYMPL pixel Node?

Yes. You can integrate multiple SYMPL pixel Nodes in your installation. As part of the e:cue SYMPL family, you can also combine it the whole SYMPL range of interfaces.

Can I use other controllers apart from the SYMPL pixel Node to control LEDs?

Yes. To control the LEDs in the installation, you can use further control devices apart from the SYMPL pixel Node.

What is the maximum distance between SYMPL pixel Node and LED fixture and what can I do to enlarge the distance?

Between the Node and the fixture, the maximum cabling distance is 3 meters. If you want to have the fixtures further away from the Node, use the Pixel Range Extender. Place it between the node and the fixture and you can enlarge the distance to up to 300 meters.



How many Pixel Range Extenders do I need per SYMPL pixel Node?

One Pixel Range Extender can extend the connection of one Pixel output. The SYMPL pixel Node has two Pixel outputs. So to extend both outputs, you need two Pixel Range Extenders.

To make ordering easier, we deliver the Extender in units of two. Simply order the same amount of product number from the Pixel Range Extender as you have SYMPL pixel Nodes.

Do I need to configure the input configuration protocol?

No. Only in one case, you need to configure the incoming protocol type: when you use e:net DMX (SYMPHOLIGHT).

In SYMPHOLIGHT, the default setting of a universes is e:pix. Change it to DMX: in the Setup tab of SYMPHOLIGHT go to the Layout window. Select "Universes" and then change the setting in the Properties window.

15.3 Power supply**How can I supply power to the SYMPL pixel Node?**

You have three options: **a)** use an external power supply unit at the Power Supply input, **b)** use pass back power from the LED fixture or its PSU at output port 1, or **c)** use PoE at the Ethernet connection. For more information see „4.5 Power supply“ on page 09.

What is „pass back power“?

You can supply power to the SYMPL pixel Node by obtaining it via the fixture. All you need is to have the fixture connected to a PSU. Please ensure that at least 4 V (min) supply reach the Node, especially when using 5 V, and check for voltage drop.

What is the minimum voltage for powering the SYMPL pixel Node?

The minimum voltage is 4.5 V DC (nominal 5 V power supply).

Can I use the SYMPL pixel Node to power the LED fixtures?

No, this is not possible. But you can use one power supply unit for both, see the recommended wiring for the SYMPL pixel Node. And the same goes for the Pixel Range Extender: use one power supply unit for the Extender and the connected LED fixture.

Is splitting possible?

In general, you can split the supply line and distribute it to several pixel products. However, the same signal is then present everywhere - splitting with address shifts is not possible.

15.4 Network**How can I change the IP address?**

To change the IP address, you can either use e:cue's SYMPHOLIGHT, see „7.2 Network configuration with SYMPHOLIGHT“ on page 18. Or the web interface, see „7.3 Network configuration with the web interface“ on page 18.

The current IP address cannot be reached. What can I do?

Make sure your SYMPL pixel Node is not in bootloader mode and try to reload the web interface. Then try to find it in SYMPHOLIGHT. Do you know its IP address? Then make sure your are in the same network as the Node. You do not know its IP address? Or you have DHCP enabled without a DHCP server in the network? Reset it. Its IP address is now by default 192.168.123.1.

Unable to open the web interface of the SYMPL pixel Node?

Please ensure that the SYMPL pixel Node and your computer are in the same network. Make sure that each device in the network has a unique IP address. With e:cue's SYMPHOLIGHT your Node will be found easily by pressing the Identify button and configured conveniently (see „7.2 Network configuration with SYMPHOLIGHT“ on page 18).



15.5 Protocols

How can I configure the LED protocols?

Head to the web interface. Here you will find the “Output Configuration” tab. For each output, select a protocol type and define its properties (see [„8.1 LED protocol configuration via web interface“ on page 20](#)).

Which input communication protocols are supported?

You can connect a range of data protocols to the SYMPL pixel Node. For the list of supported items see [„14 Supported Protocols“ on page 25](#) or check www.ecue.com for updates.

Which serial addressable LED pixel protocols are supported?

You can connect a variety of LED protocols to the SYMPL pixel Node. For the list of supported items see [„14 Supported Protocols“ on page 25](#) or check www.ecue.com for updates.

Can I create my own LED pixel protocols?

Yes. Define your own protocol using the protocol type “customized” at the Output Configuration (see [„8 Output configuration“ on page 20](#)).

How do I know which protocol is required?

This should be evident from the manufacturer’s data sheet or manual. Alternatively, the dealer of the product will be able to provide information here.

15.6 Update

Where can I find the latest firmware update?

You can find the latest firmware versions either on www.ecue.com. Or you will get a notification in SYMPHOLIGHT when an update is available. For more information see [„10 Firmware Update“ on page 22](#).

15.7 About the Pixel Range Extender

Which LED fixtures are supported by the Pixel Range Extender?

You can use fixtures with single-wire, asynchronous pixel protocols. For the list of supported items see [„14 Supported Protocols“ on page 25](#) or check www.ecue.com for updates.

How do I connect the SYMPL pixel Node and the Pixel Range Extender?

Connect the “Controller” interface of the Pixel Range Extender to a “Pixel” interface of the SYMPL pixel Node using pins “Data +”, “Data –”, and “GND”.

What is the maximum distance between Pixel Range Extender and LED fixture?

Between the Extender and the fixture, the maximum cabling distance is 3 meters.

How do I supply the Pixel Range Extender with power?

You have two options: **a)** use an external power supply unit between the Extender and the LED fixture, **b)** use pass back power from the LED fixture’s PSU when the PSU is wired behind the fixture. Connect at the “Fixture & Power” terminals. For wiring options see [„5 Wiring diagram“ on page 11](#).

What is the minimum voltage for powering the Pixel Range Extender?

The minimum voltage is 4.5 V DC (nominal 5 V power supply).

Do I need to configure the Pixel Range Extender to fit to the connected LED fixture (protocol configuration)?

The Pixel Range Extender requires no configuration. All configuration is done at the SYMPL pixel Node. To use the Pixel Range Extender the protocol’s Output mode has to be set to “Extender”.





ecue



TRAXON | ecue
MEMBER OF PROSPERITY GROUP

Please check for the latest updates and changes on the Traxon website.

© 2023 TRAXON TECHNOLOGIES. ALL RIGHTS RESERVED.

www.traxon-ecue.com