



TRAXON

Media Tube® HO

INSTALLATION GUIDE

V1.1



Cover:

Media Tube® HO RGBW/RGB/White Direct View

Media Tube® HO RGBW/RGB/White Diffused



TRAXON

CONTENT

| | | |
|----|-------------------------|----|
| 1. | INTRODUCTION | 3 |
| 2. | INSTALLATION | 6 |
| 3. | SAFETY AND OPERATION | 13 |
| 4. | SYSTEM CONFIGURATION | 14 |
| 5. | CARE AND MAINTENANCE | 20 |
| 6. | TROUBLESHOOTING | 21 |
| 7. | TECHNICAL SPECIFICATION | 22 |
| 8. | WARRANTY STATEMENT | 22 |

For your own safety and that of the product, please read this installation guide carefully before beginning setup and installation.



1. INTRODUCTION

1.1 General

| MEDIA TUBE® HO RGBW DIRECT VIEW | MEDIA TUBE® HO RGBW DIFFUSED | Length (mm) | Maximum number of pixels (PXL) |
|---------------------------------|------------------------------|-------------|--------------------------------|
| TU.CS.1112001 | TU.DS.1112001 | 296 | 12 |
| TU.CS.2124001 | TU.DS.2124001 | 596 | 24 |
| TU.CS.3136001 | TU.DS.3136001 | 896 | 36 |
| TU.CS.4148001 | TU.DS.4148001 | 1196 | 48 |
| TU.CS.5160001 | TU.DS.5160001 | 1496 | 60 |

Media Tube® HO is an IP66-rated slim LED tube for any wall or façade media lighting. Available in 296mm, 596mm, 896mm, 1196mm and 1496mm lengths, the simple but robust construction, allows up to 18.3m of tubes to be daisy chained on a single power run. The Media Tube® HO is controllable by DMX512 / e:pix / DVI capable with auto-addressing to the next tube in the daisy chain. The Media Tube® HO is housed in aluminium extrusion with a clear PC cover for direct view or with a diffused PC cover for diffused view.

Features:

- Available lengths: 296mm (12PXL), 596mm (24PXL), 896mm (36PXL), 1196mm (48PXL) and 1496mm (60PXL)
- Direct View or Diffused
- Three color options: RGBW, RGB*, White* (*available upon request)
- DMX512 / e:pix / DVI capable
- Daisy Chain System
- Auto-Addressing
- SMART CHIP™ Technology
- Outdoor Applications (IP66-rated)



TRAXON

1.2 Dimensions

FIG.1: Media Tube® HO Direct View

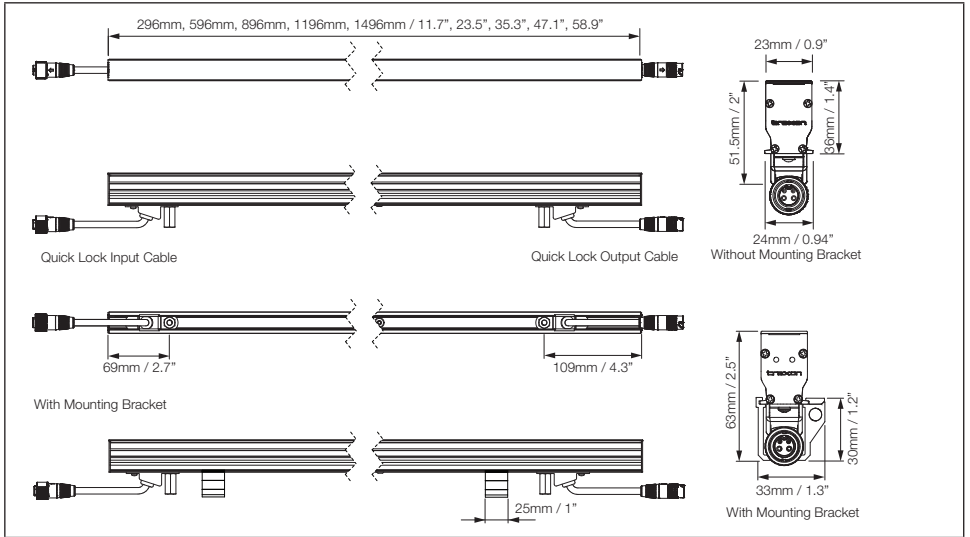
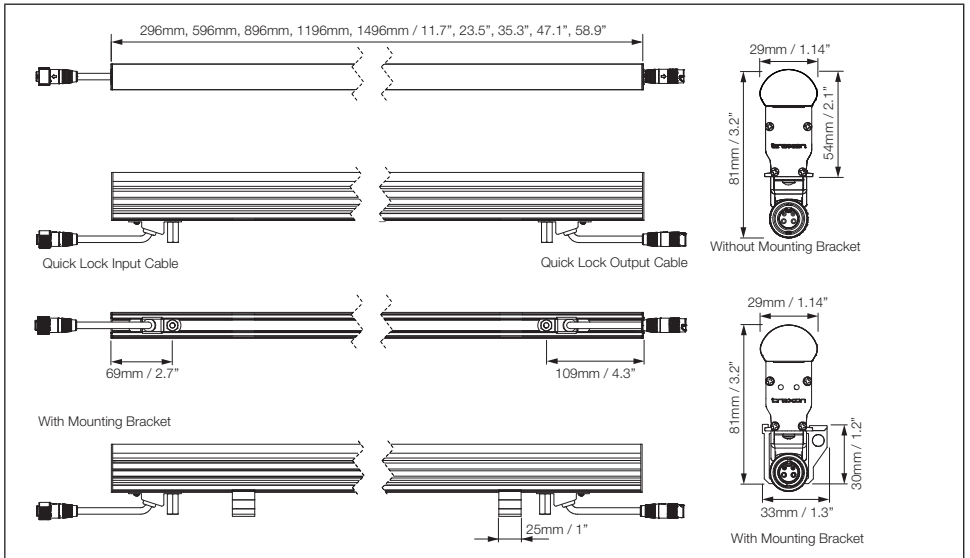

FIG.2: Media Tube® HO Diffused





TRAXON

1.3 Packing Contents

FIG.3: Packing Contents

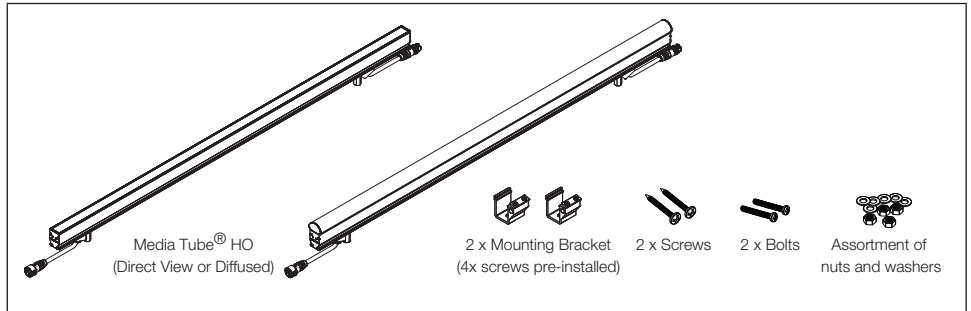



2. INSTALLATION

2.1 Points To Consider

Plan your installation before mounting the Media Tubes® HO. The following should be considered for a successful installation.

- Weather conditions and ambient temperature of installation site.
- Appropriate cable lengths (cable gauges described in below diagram). Please consult your local Traxon office or authorized agent for necessary aid.
- The number of Media Tubes® HO and appropriate LED Engines.
- DMX512/e:pix controller to be used to control the Media Tubes® HO.
- Distance between each Tube for thermal expansion and maintaining pixel pitch.
- There are two mounting methods to consider, plan mounting distances accordingly for whichever method is required.
- Proper surge protection.
- Number of standard LED Engines to be used.

FIG.4: Media Tube® HO Cable System

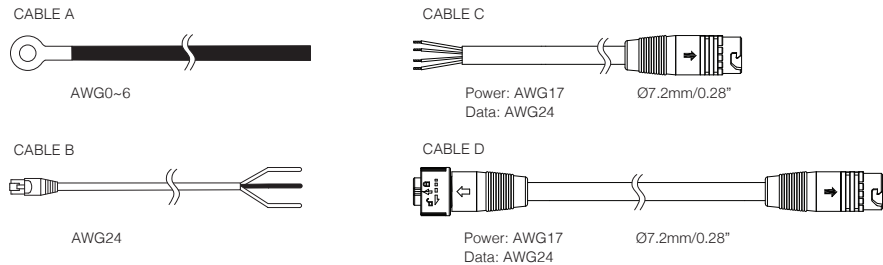

Cable A = Live power cable
(from PSU to Power Distribution Block)

Cable B = Data cable
(from VMC to Terminal Block)

Cable C = Starter cable
(From Terminal Block to first Media Tube® HO in chain)

Cable D = Interconnection cable
(From Media Tube® HO to another Media Tube® HO)



2.2 Pre-Installation Checks

2.2.1 Installation Checklist

1. Prepare cables and all necessary accessories (Mounting Brackets, Waterproof Quick Lock End Caps etc).
2. Perform functional check of Media Tubes® HO. Take care not to damage cables/connectors during pre-installation checks.
3. Ensure all pre-installation checks laid out below have been followed.
4. Mount the Media Tubes® HO on-site. If the installation is to be left uncompleted overnight, place all non-connected LED Engines and Media Tubes® HO in an indoor environment.

Ensure all the Interconnection Cables, Media Tubes® HO and LED Engines are initially stored in a dry area to guarantee the complete sealing of the system from water before installation.

2.2.2 Cable Bending

To reduce stress induced on Media Tube® HO lead cables, please adhere to the Minimum Bending Radius of 10mm (0.4") and the Non-Bendable Length of 20mm near the connector. It is recommended to install lead cables through conduits/trunking.

FIG.5: Minimum Cable Bending and Non-Bendable Length requirement

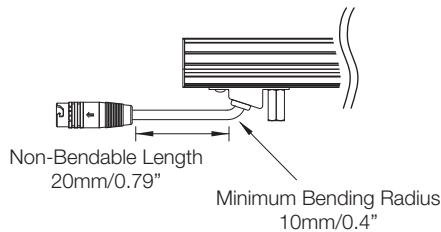

NOTE: Water ingress incurred due to cable twisting or excess cable bending will not be under warranty by Traxon Technologies.



2.2.3 Mounting Bracket

If the Mounting Bracket method of installation is used, it is recommended to fix it to the installation surface before the Media Tube® HO is secured to the bracket

FIG.6: Media Tube® HO Mounting Bracket

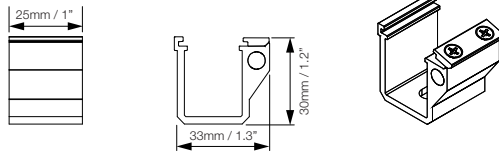

2.2.4 Installation Sequence

1. Plan for any possible bending of cables (see Section 2.2.2).
2. Measure the correct distances for Mounting Brackets.
3. Connect Media Tubes® HO with LED Engines in the daisy-chain manner outlined in the System Diagram to form large installations.
4. Perform functional check on all Media Tubes® HO and inspect cables and Mounting Bracket for any damage. Check for any abnormalities with the control signal.
5. Report any functional defect found to your nearest Traxon Technologies office. DO NOT attempt to install Media Tubes® HO with functional defects on-site.



2.3 On-Site Installation



- DO NOT attempt installation in wet or severe weather conditions.
- DO NOT leave and expose any Media Tubes® HO or LED Engines unconnected under wet/raining or snowing environment.
- IP failure induced by stressed/damaged cables during or after installation will not be under warranty by Traxon Technologies.
- ALWAYS keep the cables protected from sharp objects and ensure no damage is generated on the cable.

Failure to keep Media Tube® HO within the operating temperature range of -30°C to $+60^{\circ}\text{C}$ / -22°F to $+140^{\circ}\text{F}$ and storage temperature range of -40°C to $+70^{\circ}\text{C}$ / -40°F to $+158^{\circ}\text{F}$ will void the product's warranty.

2.3.1 On-Site Installation

1. Fix Mounting Bracket to installation surface with anchor bolts, if Mounting Bracket method is being used.
2. Attach Media Tube® HO to Mounting Bracket and affix Mounting Plate (see below diagram). If using the Mounting Studs option, simply secure using anchor bolts (see Mounting options for the Tube FIG.10).

FIG.7: Fixing the Mounting Bracket to Installation Surface

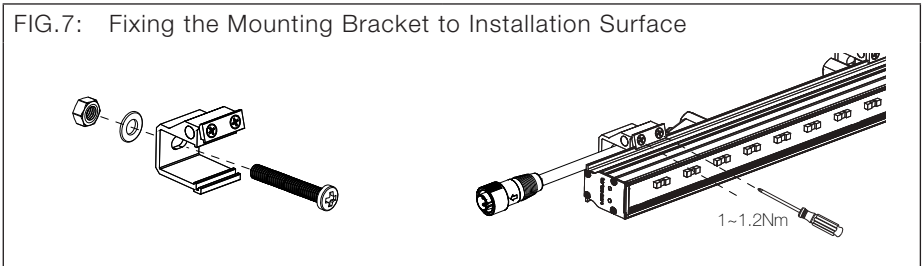



TRAXON

- The Media Tubes® HO are interconnected using the IN and OUT cables on each end of the tube. Screw the connectors tightly for a water-tight seal. Below diagram shows the Tube connections. Always remember to affix an Quick Lock Waterproof End Cap (sold separately) for the OUT connector of the final Tube in each daisy chain. See System Diagram for details.

FIG.8: Media Tube® HO Connections

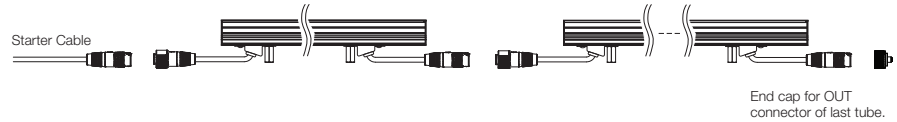

NOTE: Any water ingress incurred due to improper installation of cable connectors or Waterproof Quick Lock End Caps will not be under warranty by Traxon Technologies.

- Be sure not to compress the IN/OUT cables (see Requirements Of Cable Bending).
NOTE: To keep LED pitch consistent and allow for thermal expansion, be sure to keep a minimum distance of 4mm (0.16") between consecutive Media Tubes® HO (see below diagram).

FIG.9: Fixing the Mounting Bracket to Installation Surface

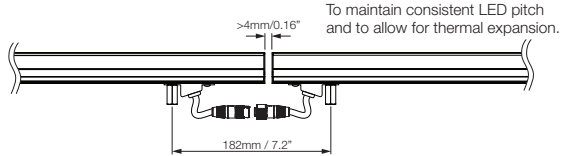



TRAXON

5. Connect Media Tubes® HO in the daisy-chained manner as detailed in the System Diagram. There are two mounting options.

FIG.10: Mounting options for the tube

Water-proof

IMPORTANT NOTE:
If no "Tak!" sound is heard or connector still not mated well, push both connectors inwards and manually rotate spring head of male connector in the locking direction.

1. By pushing the cable connectors inwards, quick lock connectors shall be mated and locked automatically.
2. Locking requirement of the quick lock connectors after mated:
 - "Tak!" sound should be heard
 - All 3 arrows should be in one straight line
 - Connector cannot be pull out
3. Wrap female and male connector as well as end cap with 3M Scotch Rubber Splicing Tape 23 (or other similar self-amalgamating rubber tape) for secondary protection in the direction opposite to the unlocking direction.
4. 3M Scotch® Rubber Splicing Tape 23* should be applied in successive half-lapped, level-wound layers until desired buildup is reached.

*For details, refer to the 3M Scotch® Rubber Splicing Tape 23 Data Sheet.

6. The first tube of the daisy-chain group has to be connected to the control system via the Quick Lock Starter Cable or the RJ45 / Power Data to Quick Lock Injector Cable Kit (TU.AC.0600400).



TRAXON

7. Starter cables, Data and Power cables, and video fiber optic cables have to be installed through conduits/trunking.

FIG.11: Bad vs. Good trunking. It is recommended to follow the example on the right.

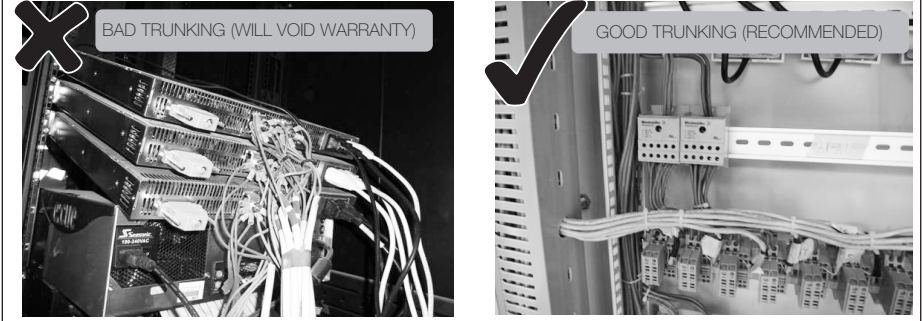

8. Set up the control system indoors as detailed in the System Diagram and connect to the Media Tubes® HO outside. Start up each unit and verify correct function.



3. SAFETY AND OPERATION

- CAUTION - Unplug the power supply from the mains power before connecting any cables as this can damage the products.
- CAUTION - Avoid looking directly into the LED light source at close range for your own safety.
- Persons installing this product should make sure:
 1. The installation complies with all applicable codes, state and local laws, ordinances, standards and safety regulations.
 2. The installation environment is carefully studied and suitable surge protection measure(s) is taken.
 3. He or she is qualified for the handling of electrical equipment.
- Do not attempt to install or use the product until installation instructions and safety labels are fully understood. This product is designed for indoor and outdoor use.
- Ensure product operates within the specified temperature range. (Refer to 7. TECHNICAL SPECIFICATION for more details.)
- Do not attempt to open the product. Not user serviceable.
- Do not use the product if any part of it, or the power cables are damaged.
- Only use product for specified voltage, do not exceed. (Refer to 7. TECHNICAL SPECIFICATION for more details.)
- Always maintain connection to ensure waterproofing.
- If the product has been subjected to drastic temperature variances, for example, following transportation, do not connect the fixture until it has reached room temperature, as moisture condensation may cause electric shock and product damages.
- When installing the products and system power supplies, please ensure they will not be exposed to moisture and extreme heat (and direct sunlight for outdoor products). Besides, keep a clean operating environment for the fixtures and system power supplies.
- Please study this Installation Guide thoroughly and check the latest Technical Specification Sheets available from the Traxon website www.traxontechnologies.com before setup.
- Any non-compliance of the Installation Guide will void the Traxon warranty.



TRAXON

4. SYSTEM CONFIGURATION

4.1 MEDIA TUBE® HO CONNECTION COMPONENTS

The Media Tube® HO is connected using a daisy chain system with power and data on the same cable. Below diagram shows some typical components for Media Tube® HO system.

FIG.12: Connection Components for Media Tube® HO System

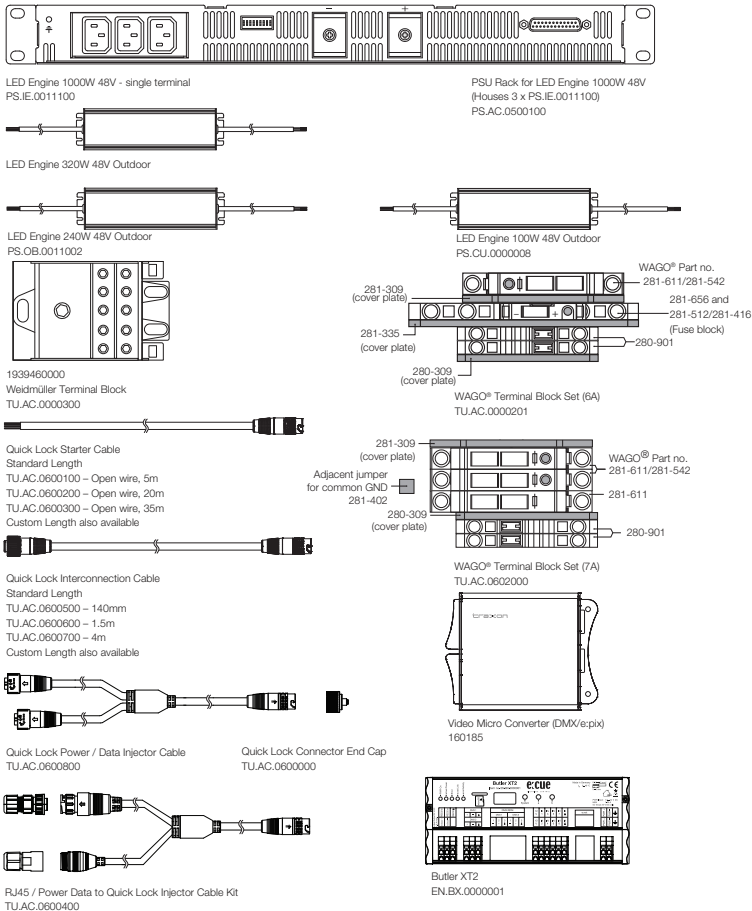



TRAXON

4.2 LED CONTROL

The LEDs on the Media Tube® HO are controlled by DMX512/e:pix. Each pixel on the Tube uses four (4) channels, for R, G, B and W. Pixel number 1 begin on the IN connector side, and it uses the first four channels.

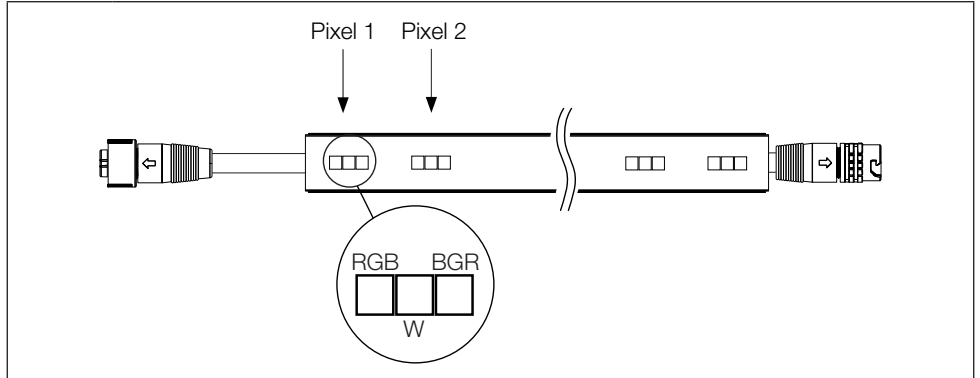

| Pixel n | Control Channel Number |
|---------|------------------------|
| R | $+4(n-1) + 1$ |
| G | $+4(n-1) + 2$ |
| B | $+4(n-1) + 3$ |
| W | $+4(n-1) + 4$ |

Where: n is pixel number along the Tube.
(Pixel 1 is located near the IN connector.)

NOTE: This is applicable for Media Tube® HO RGBW 4-channel mode only.

For “+White” / “Auto White” feature, please refer to corresponding manual.



TRAXON

FIG. 14: Media Tube® HO RGBW 1000W 6A Fuse Per Daisy Chain System Connection Example

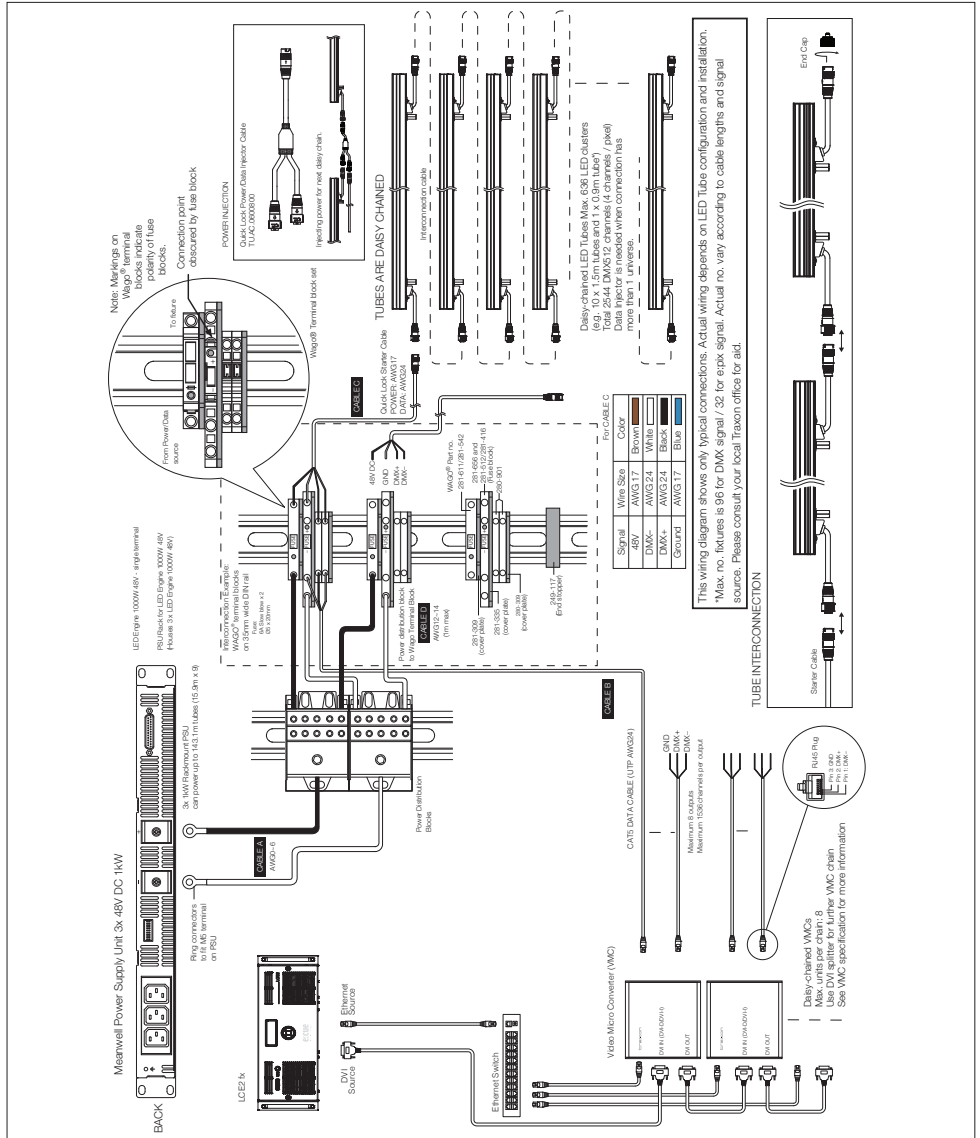



TRAXON

FIG. 15: Media Tube® HO RGBW System 320W Outdoor Connection Example

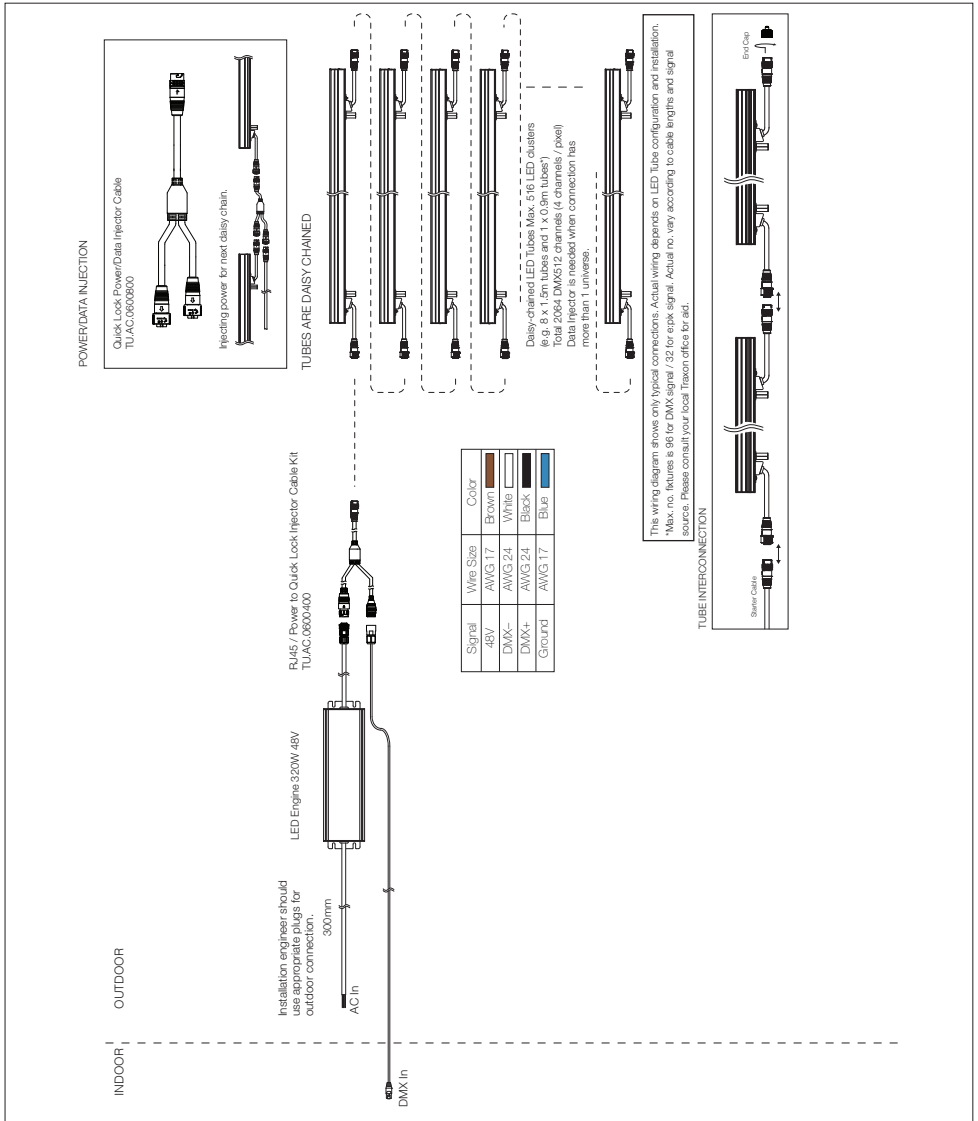



TRAXON

FIG.16: Media Tube® HO RGBW System 240W Outdoor Connection Example

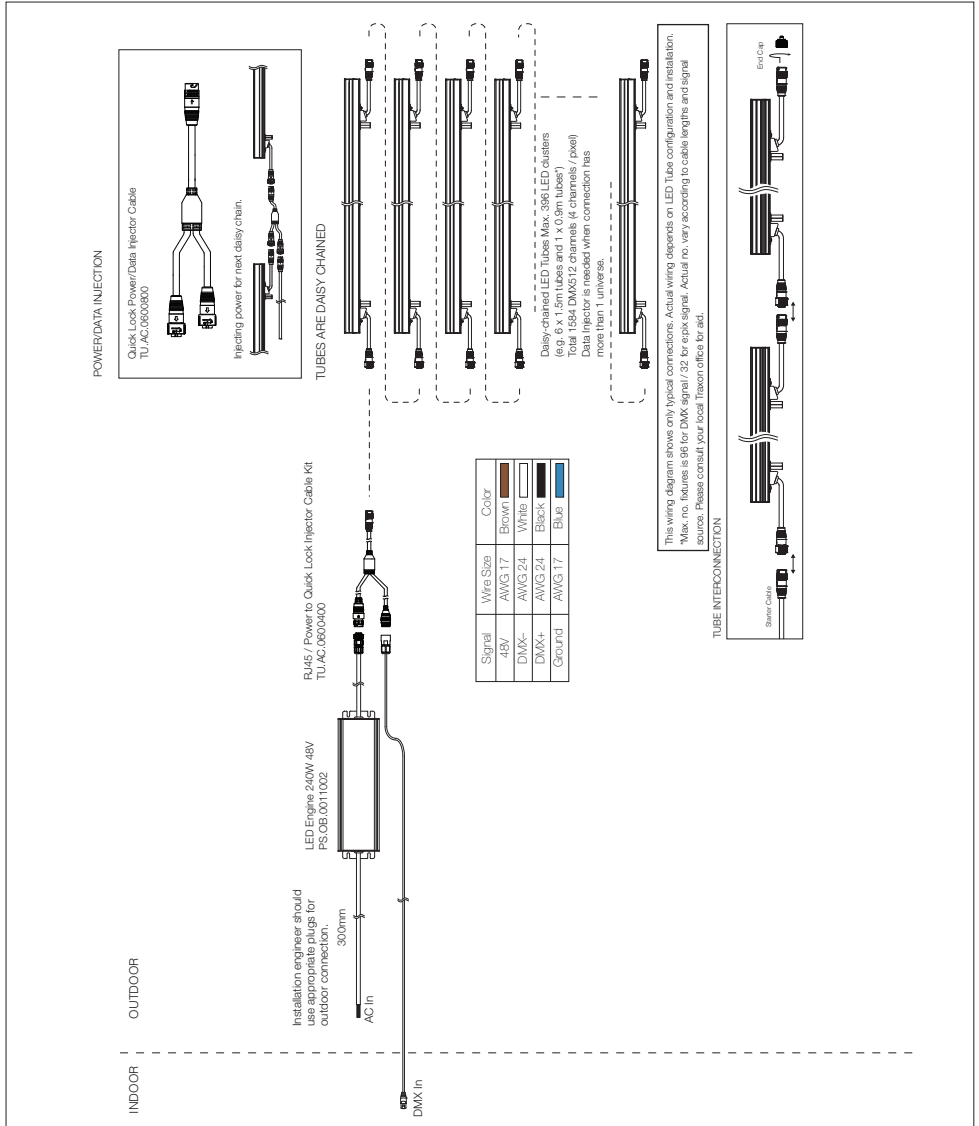



TRAXON

FIG.17: Media Tube® HO RGBW System 100W Outdoor Connection Example

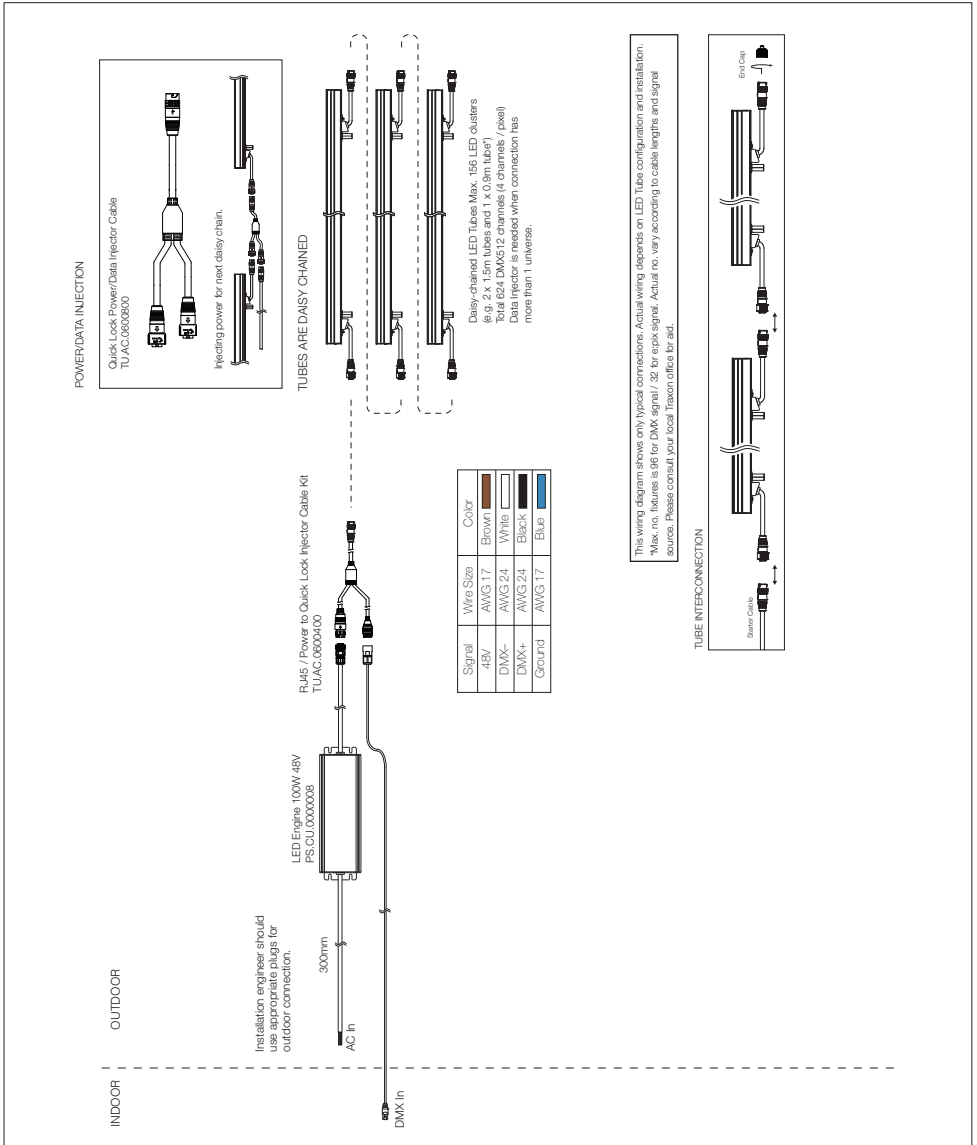



TRAXON

8.1 WAGO TERMINAL BLOCK

FIG. 18: Wago Terminal Block Wiring (6A Fuse)

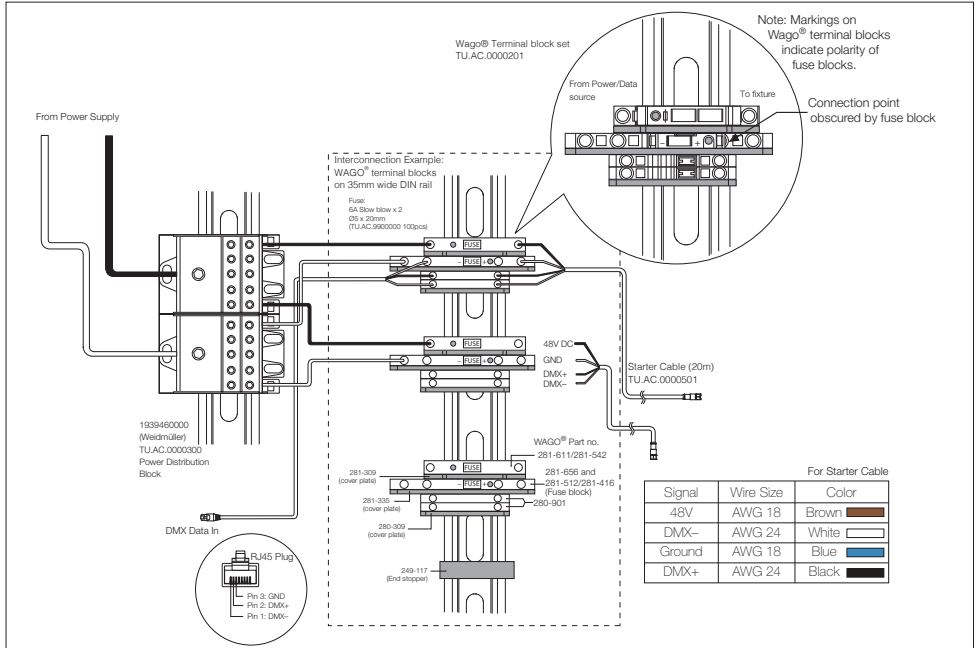

For interconnection from the power/data source to the fixture, a Weidmüller/Wago® combination is used. Polarity of Wago® fuse blocks are indicated on the top of the block. Always keep the polarity consistent, with the Live side leading to the fixture. The Indicator Lamp will trigger if there is no fuse or if the fuse has blown.

CAUTION: Ensure the polarity of the Wago® terminal blocks are correct (as shown in above diagram) to avoid causing damage to the fixture.



TRAXON

FIG. 19: Wago Terminal Block Wiring (7A Fuse)

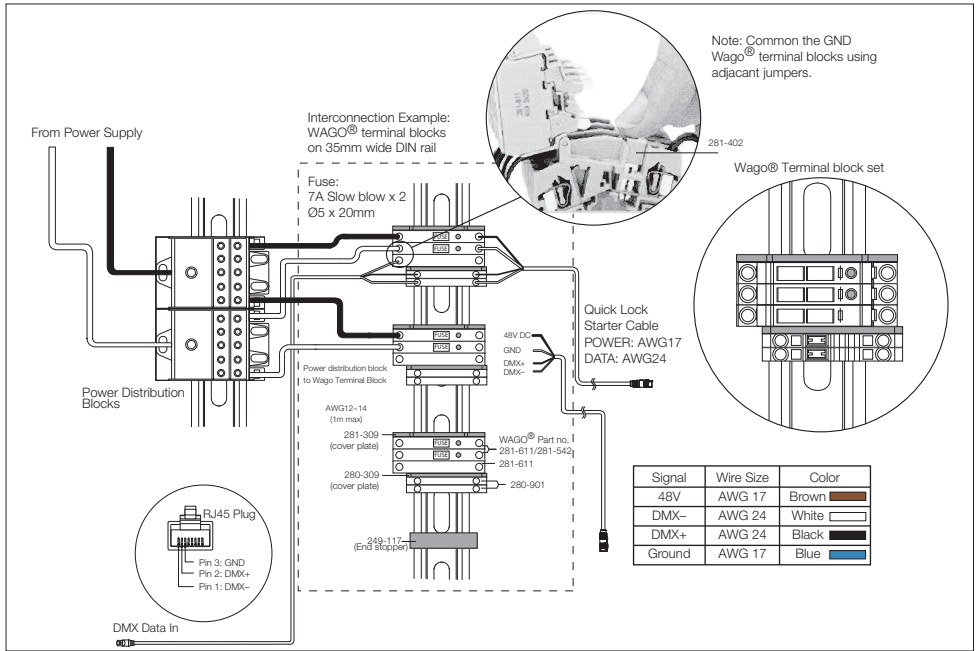

For interconnection from the power/data source to the fixture, a Weidmüller/Wago® combination is used. Always keep the polarity consistent, with the Live side leading to the fixture. The Indicator Lamp will trigger if there is no fuse or if the fuse has blown.

CAUTION: Ensure the polarity of the Wago® terminal blocks are correct (as shown in above diagram) to avoid causing damage to the fixture.



5. CARE AND MAINTENANCE

Traxon™ products are of superior design and quality and should be treated with care. The recommendations below will help fulfill any warranty obligations and gain good use and longevity from the products.

- Do not attempt or use the product(s) until you read and understand the installation instructions. Failure to adhere to these instructions could result in serious injury or property damage.
- Do not use product(s) if cables are damaged.
- Do not connect cables and connectors when wet or in wet area. Moisture on bare connectors can cause electric shock and damage to product(s).
- Do not use product(s) in extreme heat environment. Ensure there is sufficient airflow and use cool air circulation if required.
- Do not drop, knock, or shake product(s). Rough handling can damage the electronics and void the warranty.
- Do not use harsh chemicals, cleaning solvents, or strong detergents to clean products. Wipe with a damp cloth on housings and a dry cloth on electronics to remove dirt or dust.
- Do not attempt to service or repair the product(s) unless done by an authorized service personnel. Contact your local Traxon office or distributor for details.
- If the product is not working as specified, please contact your nearest authorized service center or Traxon Technologies office for assistance.



6. TROUBLESHOOTING



CAUTION: Ensure power supply is OFF when disconnecting / connecting cables.

| Problem | Cause | Possible Solutions |
|--|---|--|
| Product does NOT light up after installation | Incorrect power connection | <ul style="list-style-type: none">• Check Mains Power• Check power supply leads and wire connections• Ensure output wires are connected with proper polarity• Check Wago terminal block fuse. If Indicator Lamp is on, either the fuse is not present or it is blown.• Check if LED Engine's secondary output is working as specified. |
| Shadowing | Light source covered | <ul style="list-style-type: none">• Check for cables, wires or unwanted debris covering LED light source |
| Modules are dim | Excess products connected | <ul style="list-style-type: none">• Ensure the power supplies are not overloaded due to an excess of products connected |
| Flickering | Incorrect power input/ Excess products connected | <ul style="list-style-type: none">• Ensure the input voltage is correct• Ensure the power supplies are not overloaded due to an excess of products connected |

If problems persist or the product is not working as specified, please contact your nearest authorized service center or Traxon Technologies office for assistance.



7. TECHNICAL SPECIFICATION

Media Tube® HO RGBW

| | |
|---------------------------|---|
| Color Range: | 16.7 million additive RGB colors; White CCT 6500K |
| Light Source: | High intensity SMT RGB and White LEDs |
| Beam Angle: | 110° (direct view); 175°(diffused) |
| Power Input*: | 48V DC |
| Power Consumption (typ).: | 4.6W / 8.6W / 12.5W / 16.6W / 20.9W |
| Weight: | 0.36kg / 0.58kg / 0.8kg / 1.02kg / 1.24kg (direct view) 0.4kg / 0.52kg / 0.84kg / 1.06kg / 1.28kg (diffused) |
| Operating Temperature: | -30°C to +60°C / -22°F to +140°F |
| Storage Temperature: | -40°C to +70°C / -40°F to +158°F |

*For use with TRAXON LED Engine 1000W 48V Indoor (PS.IE.0011100), LED Engine 320W 48V Outdoor, LED Engine 240W 48V Outdoor (PS.OB.0011002), LED Engine 100W 48V Outdoor (PS.CJ.0000008) PSUs.

As with all electronic devices, LED output degrades over time - a term called lumen depreciation. This also explains why it is nearly impossible to expect photometric performances of two LED products with different service life spans to be the same. The rate of LED degradation is a complex function of many factors such as operating efficiency, duration of continuous operation, and operating conditions (e.g. ambient temperature).

Because LEDs are semiconductor devices, their performances are subject to inherent variability commonly found in semiconductor industry. To improve consistency in performance across the same product, LED manufacturers “sort” LEDs into bins according to different preset parameters, such as forward driving voltage, illumination, etc. Whereas binning is a sorting function, it is not a correction process. Inherent variability in the manufacturing process always results in different binning distributions according to different production lots. Traxon uses automatically binned LEDs on its products, thereby minimizing output variations within the model range.

8. WARRANTY STATEMENT

Traxon Technologies warrants its Products against material or workmanship defects for a period of five (5) years from date of purchase, provided that the purchased items are used under the conditions stated in this user manual.

Please refer www.traxon-ecue.com for all warranty terms and conditions.



TRAXON
