



TRAXON

Date: _____ Quantity: _____

Company: _____

Project: _____



ProPoint® Linear HO Dynamic White

The ProPoint Linear Dynamic White is an AC Line powered luminaire in a slim profile. The ProPoint Linear Dynamic White is available in 8W (SO) or 12W (HO) per foot output, 4 beam options, standard & custom finishes which can meet the needs for most projects. The daisy chain topology is augmented with a separate Data Injector allowing single cable feed combining data and power to fixtures.



Product Specifications

Model	ProPoint Linear HO Dynamic White 1'	ProPoint Linear HO Dynamic White 4'
Light Source	2200K/6500K LED Cluster x 5	2200K/6500K LED Cluster x 20
Color Range	DW (2200K - 6500K)	
Beam Angle	15°, 25°, 35°, 50° x 30°, 105° x 105°	
Luminous Flux	681 lm @15°	2,460 lm @15°
Efficacy	53 lm/W @15°	53 lm/W @15°
Lumen Maintenance	L70 @ 25° 81,000 hours	
Cover Lens	Tempered Glass	
Housing	Die Cast Aluminum	
Adjustment Options	±90°	
Dimensions (L x W x H)	300mm x 58mm x 90mm (12" x 2.3" x 3.6")	1200mm x 58mm x 90mm (48" x 2.3" x 3.6")
Weight	1.35 kg (3 lbs.)	3.6 kg (8 lbs.)
Regulatory Listing & Safety Approval	cETLus, FCC, RoHS, ASTM B117-16, ANSI 3G, IK08	
Operating Temperature	-30°C to +55°C (-22°F to +131°F)	
Storage Temperature	-40°C to +80°C (-40°F to +176°F)	
Minimum Starting Temperature	-20°C (-4°F)	
Environment	IP66 Outdoor, suitable for coastal environments	
Humidity	85%, non-condensing	

Electrical Specifications

Input Voltage ¹	100-277Vac 50/60Hz	
Power Consumption	12W	48W
Power Factor	≥ 0.9	

System Specifications

Power	AC line
Control	DMX512, RDM Enabled
Power Supply	Integrated

1. Auto-switching. Single phase (line, neutral and ground).

LED CHARACTERISTICS Because LEDs are semiconductor devices, their performances are subject to inherent variability commonly found in semiconductor industry. To improve consistency in performance across the same product, LED manufacturers "sort" LEDs into bins according to different preset parameters, such as forward driving voltage, illumination, etc. Whereas binning is a sorting function, it is not a correction process. Inherent variability in the manufacturing process results always in different binning distributions according to different production lots. Traxon uses automatically binned LEDs on its products, thereby minimizing output variations within the model range.

As with all electronic devices, LED output degrades over time – a term called lumen depreciation. This also explains why it is nearly impossible to expect photometric performances of two LED products with different service life spans to be the same. The rate of LED degrade is a complicated function of many factors such as operating efficiency, duration of continuous operation, and more significantly, environmental conditions (ambient temperature for example). If allowed working under optimal operating temperature range and with good ventilation, LED devices enjoy long service lives over conventional light sources. When using/installing LED devices, care should be taken to ensure that the devices will operate within the operating conditions specified in respective product literature.

This product contains a light source of energy efficiency class G to Regulation (EU) No 2019/2015. Lumen measurement complies with LM-79-08 standard. Lumen maintenance is calculated based on LM-80 compliant measurement.



www.traxon-ecue.com

©2023 TRAXON TECHNOLOGIES - AN OSRAM BUSINESS. ALL RIGHTS RESERVED. TRAXON™, TX CONNECT®, ARE TRADEMARKS OF TRAXON TECHNOLOGIES. U.S. PATENTS, E.U. PATENTS, JAPAN PATENTS, OTHER PATENTS PENDING. SPECIFICATIONS ARE SUBJECT TO CHANGE WITHOUT NOTICE.



TRAXON

ProPoint® Linear HO Dynamic White

Photometrics

Source Specifications

LED Source	2200K / 6500K LED clusters x5 / x20
Beam Angle	15°
Cover Lens	Tempered Glass

Candela Distribution

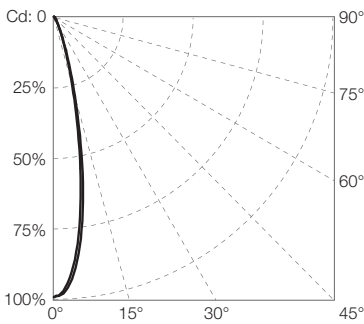

Light Output

Color	Luminous Flux (lm)	Candela Distribution at 100%	Efficacy (lm/W)
ProPoint Linear HO Dynamic White 15° 1'			
White (full on)	681.86	3,466.05	53.27
Warm White (2200K)	259.45	1,317.14	37.60
Warm White (2700K)	334.32	1,691.86	42.32
Neutral White (4000K)	623.39	3,137.17	54.68
Cold White (6500K)	426.25	2,161.91	61.78
ProPoint Linear HO Dynamic White 15° 4'			
White (full on)	2,460.4	11,513.32	53.26
Warm White (2200K)	927.3	4,425.55	38.00
Warm White (2700K)	1,223.5	5,857.9	42.78
Neutral White (4000K)	2,295.6	10,861.17	54.01
Cold White (6500K)	1,519.5	7,043.75	61.52

Illuminance at a Distance

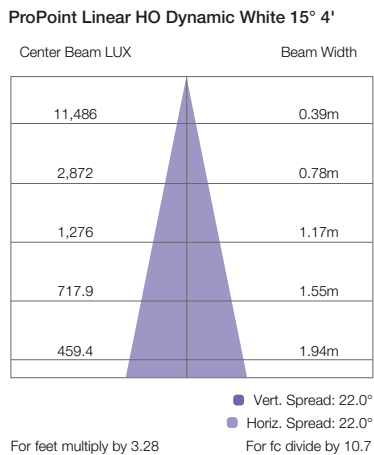
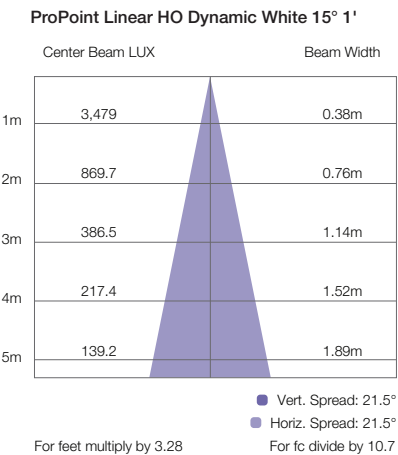



TRAXON

ProPoint® Linear HO Dynamic White

Photometrics

Source Specifications

LED Source	2200K / 6500K LED clusters x5 / x20
Beam Angle	25°
Cover Lens	Tempered Glass

Candela Distribution

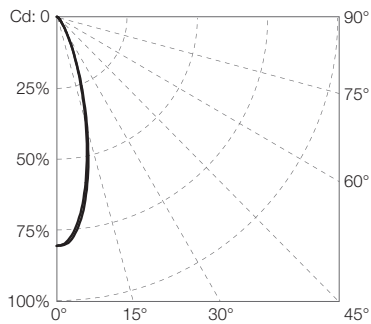

Light Output

Color	Luminous Flux (lm)	Candela Distribution at 100%	Efficacy (lm/W)
ProPoint Linear HO Dynamic White 25° 1'			
White (full on)	617.16	1,609.96	48.98
Warm White (2200K)	233.31	612.02	34.62
Warm White (2700K)	304.9	802.18	39.09
Neutral White (4000K)	577.26	1,512.68	50.20
Cold White (6500K)	387.81	1,017.64	57.88
ProPoint Linear HO Dynamic White 25° 4'			
White (full on)	2,231.4	5,677.08	48.51
Warm White (2200K)	856.78	2,205.56	34.69
Warm White (2700K)	1,177.3	3,031.02	40.32
Neutral White (4000K)	2,079.2	5,323.48	49.50
Cold White (6500K)	1,386.7	3,538.74	56.37

Illuminance at a Distance

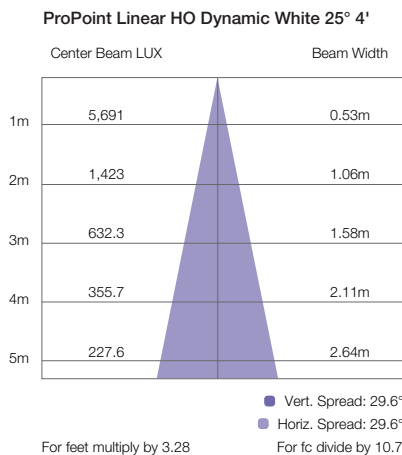
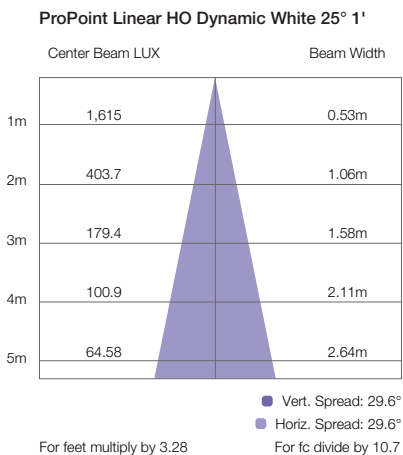



TRAXON

ProPoint® Linear HO Dynamic White

Photometrics

Source Specifications

LED Source	2200K / 6500K LED clusters x5 / x20
Beam Angle	35°
Cover Lens	Tempered Glass

Candela Distribution

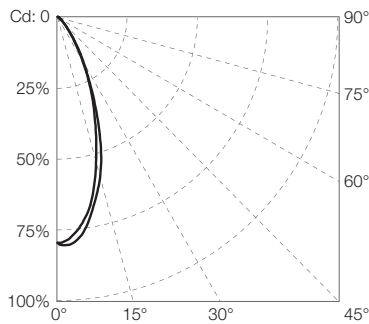
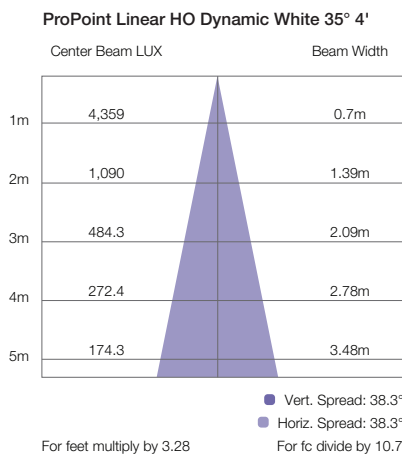
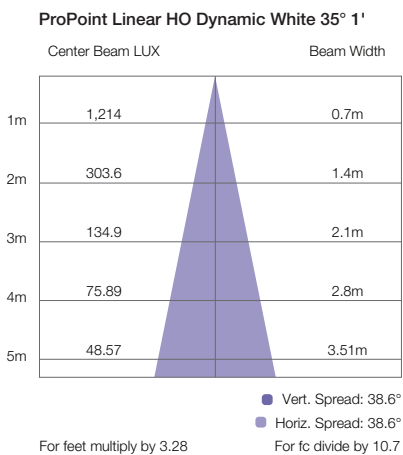

Diagram based on HO 1' Dynamic White 35°

Light Output

Color	Luminous Flux (lm)	Candela Distribution at 100%	Efficacy (lm/W)
ProPoint Linear HO Dynamic White 35° 1'			
White (full on)	660.69	1,209.40	52.02
Warm White (2200K)	246.44	465.79	36.78
Warm White (2700K)	320.62	607.75	41.64
Neutral White (4000K)	605.15	1,134.28	53.55
Cold White (6500K)	410.24	765.48	61.23
ProPoint Linear HO Dynamic White 35° 4'			
White (full on)	2,416.5	4,347.81	52.53
Warm White (2200K)	906.87	1,693.83	37.63
Warm White (2700K)	1,167.4	2,216.82	41.99
Neutral White (4000K)	2,265.1	4,287.55	53.05
Cold White (6500K)	1,505.8	2,853.67	60.47

Illuminance at a Distance





TRAXON

ProPoint® Linear HO Dynamic White

Photometrics

Source Specifications

LED Source	2200K / 6500K LED clusters x5 / x20
Beam Angle	50° x 30°
Cover Lens	Tempered Glass

Candela Distribution

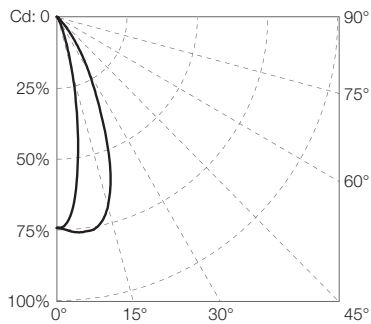

Light Output

Color	Luminous Flux (lm)	Candela Distribution at 100%	Efficacy (lm/W)
ProPoint Linear HO Dynamic White 50° x 30° 1'			
White (full on)	614.87	1,531.27	48.04
Warm White (2200K)	231.35	579.94	34.02
Warm White (2700K)	299.96	749.12	38.46
Neutral White (4000K)	557.66	1,387.34	49.35
Cold White (6500K)	384.36	952.71	55.70
ProPoint Linear HO Dynamic White 50° x 30° 4'			
White (full on)	2228	5,381.27	48.33
Warm White (2200K)	850.85	2,062.82	34.73
Warm White (2700K)	1,086.8	2,654.56	38.95
Neutral White (4000K)	2,068.7	5,001.34	49.37
Cold White (6500K)	1,385.5	3,350.22	56.55

Illuminance at a Distance

ProPoint Linear HO Dynamic White 50° x 30° 1'

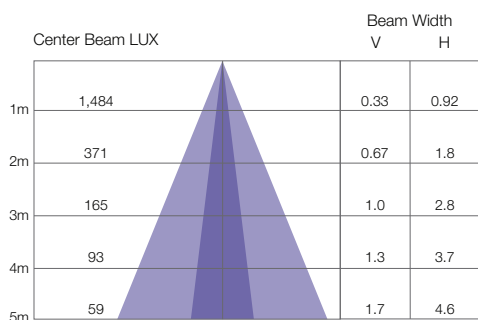

- Vert Spread: 19.0°
- Horiz Spread: 49.6°

For feet multiply by 3.28

For fc divide by 10.7

ProPoint Linear HO Dynamic White 50° x 30° 4'

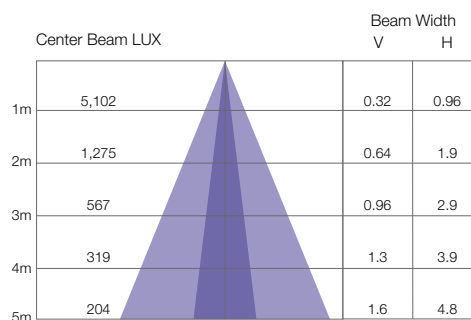

- Vert Spread: 18.2°
- Horiz Spread: 51.4°

For feet multiply by 3.28

For fc divide by 10.7



www.traxon-ecue.com

©2023 TRAXON TECHNOLOGIES - AN OSRAM BUSINESS. ALL RIGHTS RESERVED. TRAXON™, TX CONNECT®, ARE TRADEMARKS OF TRAXON TECHNOLOGIES. U.S. PATENTS, E.U. PATENTS, JAPAN PATENTS, OTHER PATENTS PENDING. SPECIFICATIONS ARE SUBJECT TO CHANGE WITHOUT NOTICE.



TRAXON

ProPoint® Linear HO Dynamic White

Dimensions

ProPoint Linear 1'

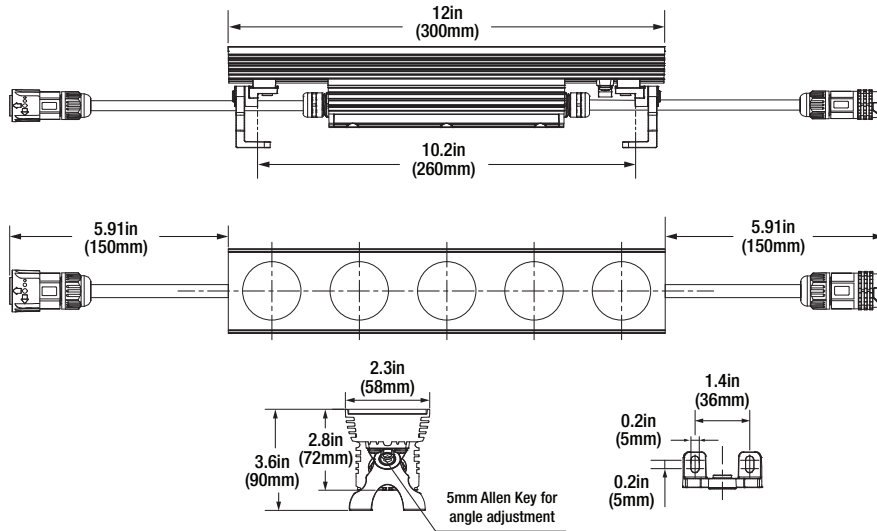

ProPoint Linear 4'

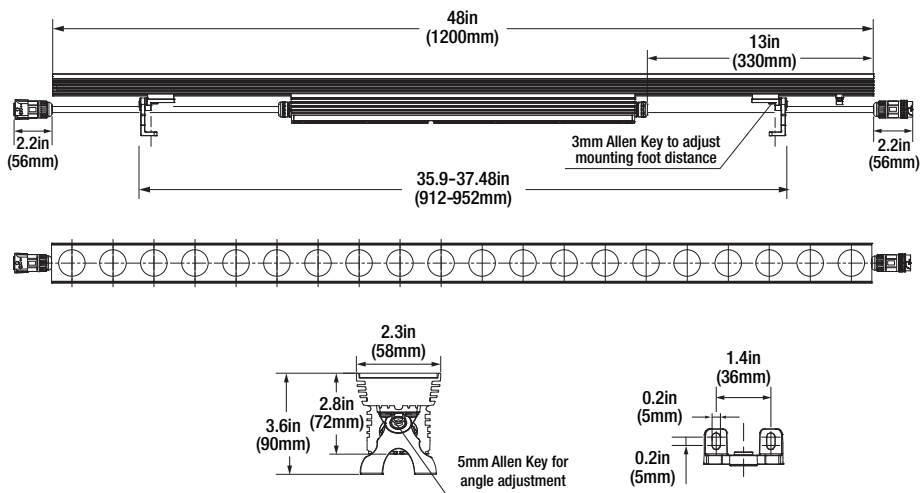



TRAXON

ProPoint® Linear HO Dynamic White

System Diagram

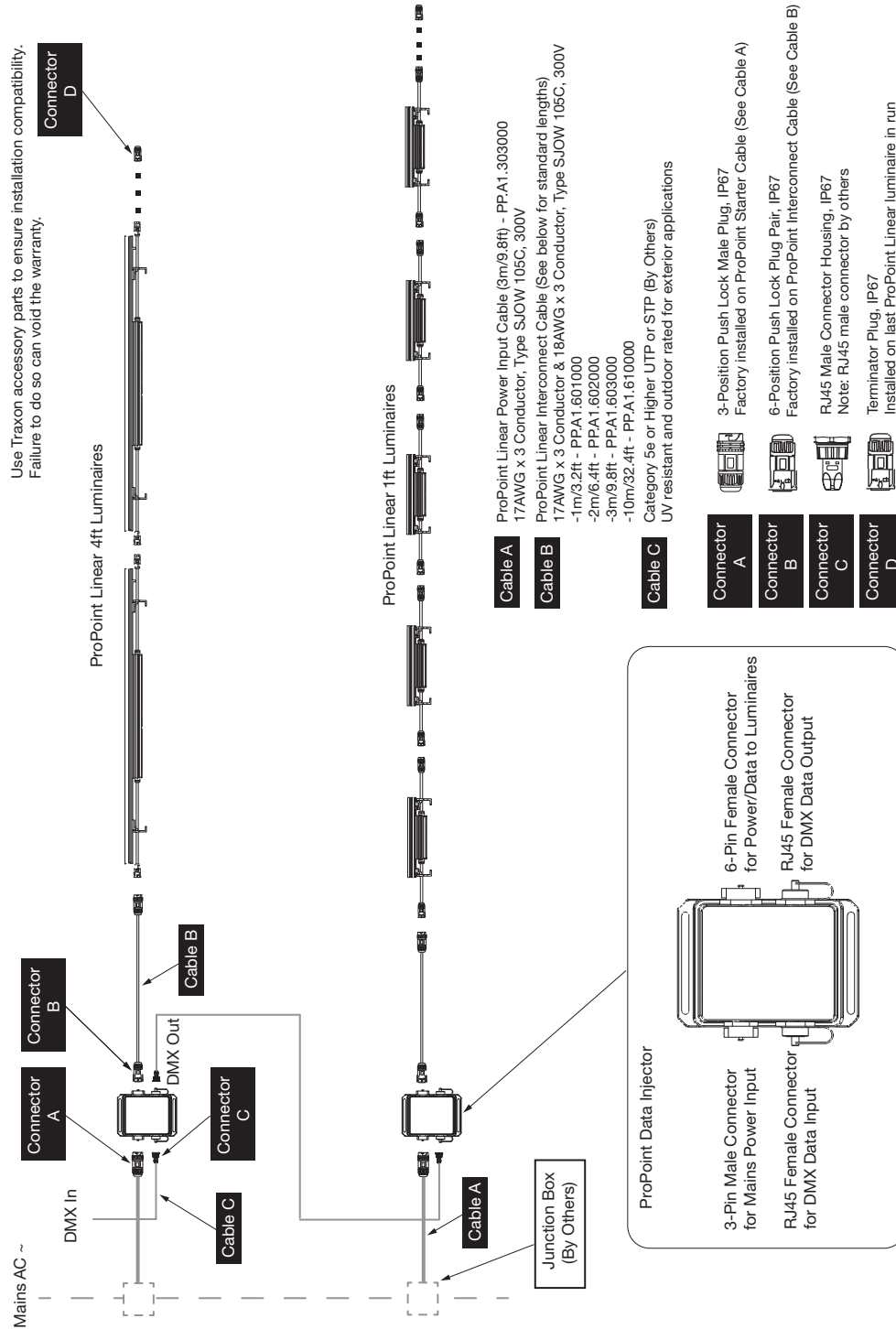

www.traxon-ecue.com

©2023 TRAXON TECHNOLOGIES - AN OSRAM BUSINESS. ALL RIGHTS RESERVED. TRAXON™, TX CONNECT®, ARE TRADEMARKS OF TRAXON TECHNOLOGIES. U.S. PATENTS, E.U. PATENTS, JAPAN PATENTS, OTHER PATENTS PENDING. SPECIFICATIONS ARE SUBJECT TO CHANGE WITHOUT NOTICE.



TRAXON

ProPoint® Linear HO Dynamic White

Ordering

Fixtures Model Number

PP	.	XX	.	9	2	7	4	X	X
ProPoint		Linear HO		Control	Color	CCT	Approbation	Optic	Finish
		L1 - 4' 48W		9: DMX	2: DW	7: 2200K-6500K	4: cETLus	2: 15°	1: Gray
		L4 - 1' 12W						3: 25°	2: Black
								4: 35°	3: White
								5: 50° x 30°	
								6: 105° x 105°	

Desired Model Number:

PP	.	XX	.	9	2	7	4		
----	---	----	---	---	---	---	---	--	--

Fixtures

Model No.	Description	Item Code
PPL4.927421	ProPoint Linear HO (12W) 1' DW 15°	
PPL4.927431	ProPoint Linear HO (12W) 1' DW 25°	
PPL4.927441	ProPoint Linear HO (12W) 1' DW 35°	
PPL4.927451	ProPoint Linear HO (12W) 1' DW 50°x30°	
PPL1.927421	ProPoint Linear HO (48W) 4' DW 15°	
PPL1.927431	ProPoint Linear HO (48W) 4' DW 25°	
PPL1.927441	ProPoint Linear HO (48W) 4' DW 35°	
PPL1.927451	ProPoint Linear HO (48W) 4' DW 50°x30°	
PPL4.927422	ProPoint Linear HO (12W) 1' DW 15° BL	
PPL4.927432	ProPoint Linear HO (12W) 1' DW 25° BL	
PPL4.927442	ProPoint Linear HO (12W) 1' DW 35° BL	
PPL4.927452	ProPoint Linear HO (12W) 1' DW 50°x30° BL	
PPL1.927422	ProPoint Linear HO (48W) 4' DW 15° BL	
PPL1.927432	ProPoint Linear HO (48W) 4' DW 25° BL	
PPL1.927442	ProPoint Linear HO (48W) 4' DW 35° BL	
PPL1.927452	ProPoint Linear HO (48W) 4' DW 50°x30° BL	
PPL4.927423	ProPoint Linear HO (12W) 1' DW 15° WT	
PPL4.927433	ProPoint Linear HO (12W) 1' DW 25° WT	
PPL4.927443	ProPoint Linear HO (12W) 1' DW 35° WT	
PPL4.927453	ProPoint Linear HO (12W) 1' DW 50°x30° WT	
PPL1.927423	ProPoint Linear HO (48W) 4' DW 15° WT	
PPL1.927433	ProPoint Linear HO (48W) 4' DW 25° WT	
PPL1.927443	ProPoint Linear HO (48W) 4' DW 35° WT	
PPL1.927453	ProPoint Linear HO (48W) 4' DW 50°x30° WT	



TRAXON

www.traxon-ecue.com

©2023 TRAXON TECHNOLOGIES - AN OSRAM BUSINESS. ALL RIGHTS RESERVED. TRAXON™, TX CONNECT®, ARE TRADEMARKS OF TRAXON TECHNOLOGIES. U.S. PATENTS, E.U. PATENTS, JAPAN PATENTS, OTHER PATENTS PENDING. SPECIFICATIONS ARE SUBJECT TO CHANGE WITHOUT NOTICE.



ProPoint® Linear HO Dynamic White

Ordering

Accessories

Model No.	Description	Item Code
PP.AC.100001	ProPoint Data Injector Box (cETLus/CE)	AM280370055
PP.AC.100002	ProPoint Data Injector Box (cETLus/CE) BL	
PP.AC.100003	ProPoint Data Injector Box (cETLus/CE) WT	
PP.AC.600000	ProPoint Linear End Cap w/ Termination Resistor	AM280380055
PP.AC.400000	ProPoint RJ45 Field Install Connectors (pair)	AM280400055
PP.A1.303000	3m Power Input Cable (cETLus)	AM280360055
PP.A1.601000	1m ProPoint Linear Power/Data Int Cable (cETLus)	AM280310055
PP.A1.602000	2m ProPoint Linear Power/Data Int Cable (cETLus)	AM280330055
PP.A1.603000	3m ProPoint Linear Power/Data Int Cable (cETLus)	AM280340055
PP.A1.610000	10m ProPoint Linear Power/Data Int Cable (cETLus)	AM280350055
PP.LA.200011	Asymmetric Louver 1'	
PP.LA.200012	Asymmetric Louver 1' BL	
PP.LA.200013	Asymmetric Louver 1' WT	
PP.LA.200041	Asymmetric Louver 4'	
PP.LA.200042	Asymmetric Louver 4' BL	
PP.LA.200043	Asymmetric Louver 4' WT	
PP.LA.100001	Wall Mount Arm	
PP.LA.100002	Wall Mount Arm BL	
PP.LA.100003	Wall Mount Arm WT	
PP.AK.000003	ProPoint 3mm Allen Key	
PP.AK.000005	ProPoint 5mm Allen Key	