



Project: _____

Type: _____



Vista Plus 1x200W RGBW

The Vista Plus RGBW is an AC line powered, high brightness luminaire. Controllable with DMX512, the Vista Plus RGBW is available in 200W and 400W output, 12 beam angle options, standard & custom finishes which can meet the needs for most projects. The daisy chain topology, and direct-wire nature of the fixture via the two integral cable whips allow for simple installation into existing installations and new structures, and is ideal for high-rise and tower illumination. This product is intended for use in high-quality colored light applications.



Product Specifications

Model	Vista Plus 1x200W RGBW
Light Source	Discrete LED x 84
Color Range	RGBW (White CCT: 4000K standard) Other White CCT and RGBA available ¹
Beam Angle	3° native ² ; 5°, 8°, 10°, 15°, 20°, 30°, 40°, 55°, 80°, 50° x 10°, 50° x 5° via accessory Internal Louver (Standard)
Luminous Flux	12213 lm
Efficacy	60 lm/W
Lumen Maintenance	L70 @ 25° 81,000 hours
Cover Lens	Tempered Glass
Housing	Die Cast Aluminum
Housing Finish Options	Gray (RAL7015), Black (RAL9005), White (RAL9003)
Adjustment Options	±90° Vertical
Dimensions (W x H x D)	680mm x 352mm x 268mm (26.8" x 13.9" x 10.6")
Weight	22.3 kg (49.17 lbs.)
EPA (sq.ft)	Front: 1.17 Side: 0.63
Regulatory Listing & Safety Approval	cETLus, CE, UKCA, FCC, RoHS, REACH, ASTM B117-16, ANSI 3G, IK08
Operating Temperature	-30°C to +55°C / -22°F to +131°F
Minimum Starting Temperature	-20°C / -4°F
Storage Temperature	-40°C to +80°C / -40°F to +176°F
Environment	IP66 Outdoor, suitable for coastal environments
Humidity	85%, non-condensing

Electrical Specifications

Input Voltage³	100-277VAC 50/60Hz
Power Consumption	200W
Power Factor	≥ 0.9

System Specifications

Technology	DynaMood®: BeamOne
Control	DMX512, RDM Enabled
Power	AC Line
Power Supply	Integrated

1. No MOQ required. Please consult regional sales office for pricing and lead time.
 2. 3° native with actual measurement of avg. 3.8°.
 3. Auto-switching. Single phase (line, neutral and ground).

LED CHARACTERISTICS Because LEDs are semiconductor devices, their performances are subject to inherent variability commonly found in semiconductor industry. To improve consistency in performance across the same product, LED manufacturers "sort" LEDs into bins according to different preset parameters, such as forward driving voltage, illumination, etc. Whereas binning is a sorting function, it is not a correction process. Inherent variability in the manufacturing process results always in different binning distributions according to different production lots. Traxon uses automatically binned LEDs on its products, thereby minimizing output variations within the model range.

As with all electronic devices, LED output degrades over time – a term called lumen depreciation. This also explains why it is nearly impossible to expect photometric performances of two LED products with different service life spans to be the same. The rate of LED degrade is a complicate function of many factors such as operating efficiency, duration of continuous operation, and more significantly, environmental conditions (ambient temperature for example). If allowed working under optimal operating temperature range and with good ventilation, LED devices enjoy long service lives over conventional light sources. When using/installing LED devices, care should be taken to ensure that the devices will operate within the operating conditions specified in respective product literature.

This product contains a light source of energy efficiency class G to Regulation (EU) No 2019/2015.
 Lumen measurement complies with LM-79-08 standard.
 Lumen maintenance is calculated based on LM-80 compliant measurement.



Source Specifications

Optics 3° native²

Candela Distribution

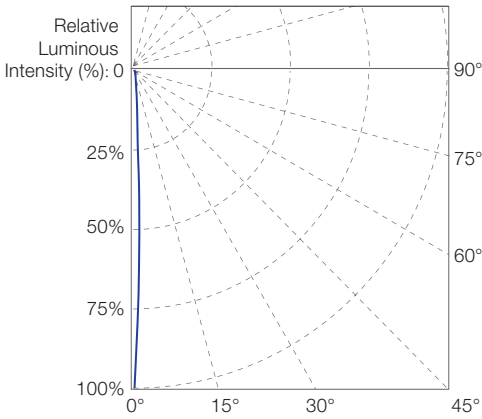

Light Output

Color	Luminous Flux (lm)	Center Intensity (cd)	Efficacy (lm/W)
RGBW FULL ON	12213	1121289	60
RGB ON	6024	554377	49
Red ON	1413	139890	48
Green ON	4183	374702	55
Blue ON	568	46376	19
White ON	6386	579329	73

Illuminance at a Distance

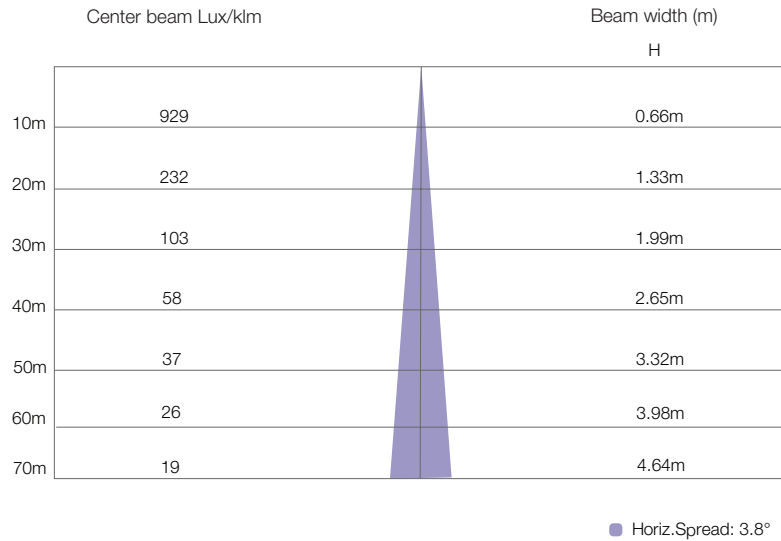

For fc divide by 10.7

For feet multiply by 3.28

IES and LDT files are available for download from the Traxon website.

Data may subject to change, please always download the latest copy from Traxon website.

². 3° native with actual measurement of avg. 3.8°.

Fixture

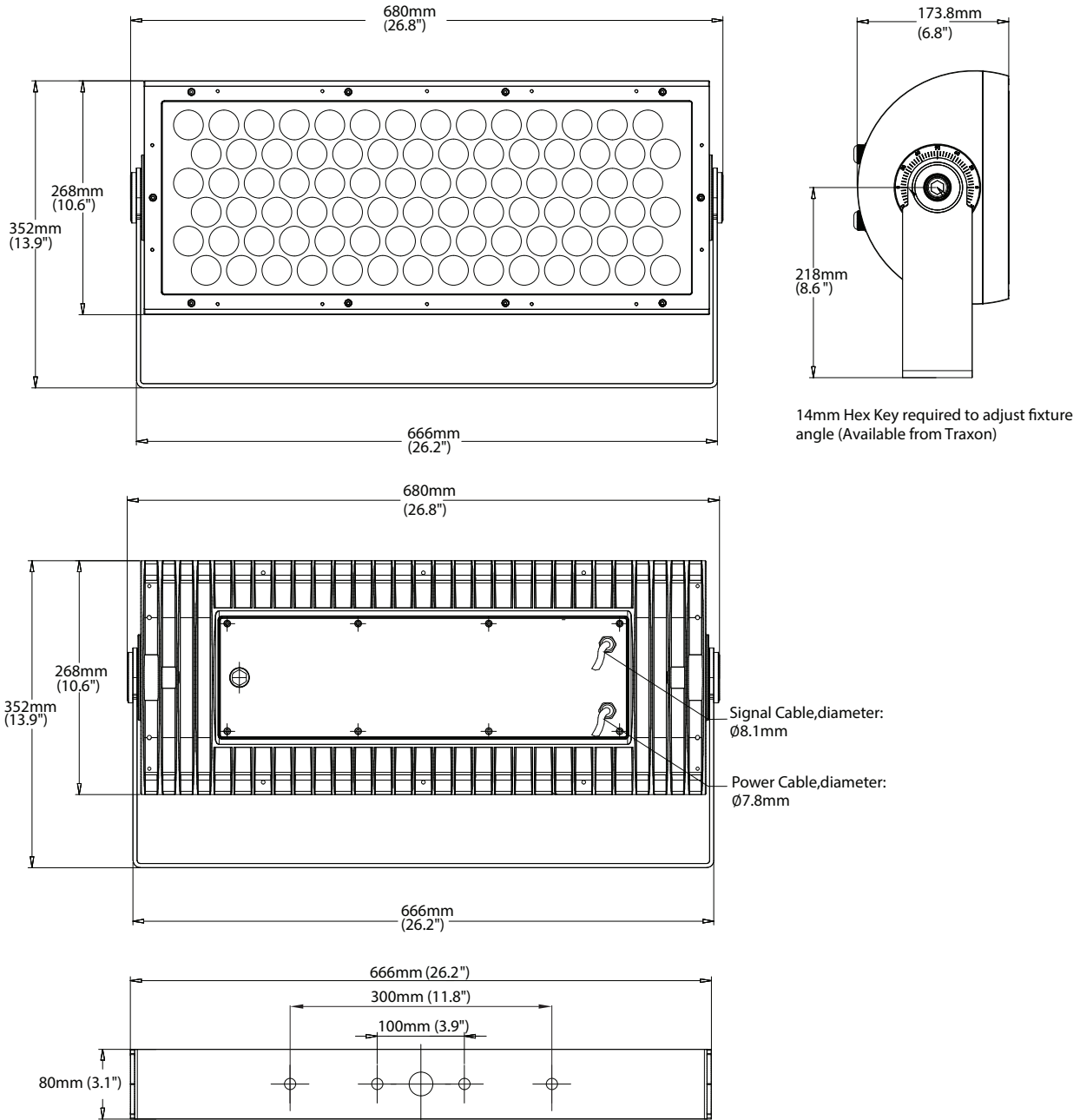

Vista Plus 1x200W open wire cable lengths

	Power input cable	Data in/out cable (combined)
Cable Length (open wire)	1830mm (72")	1830mm (72")
Cable Outer Diameter	7.8mm (0.31")	8.1mm (0.32")

Full Glare Shield

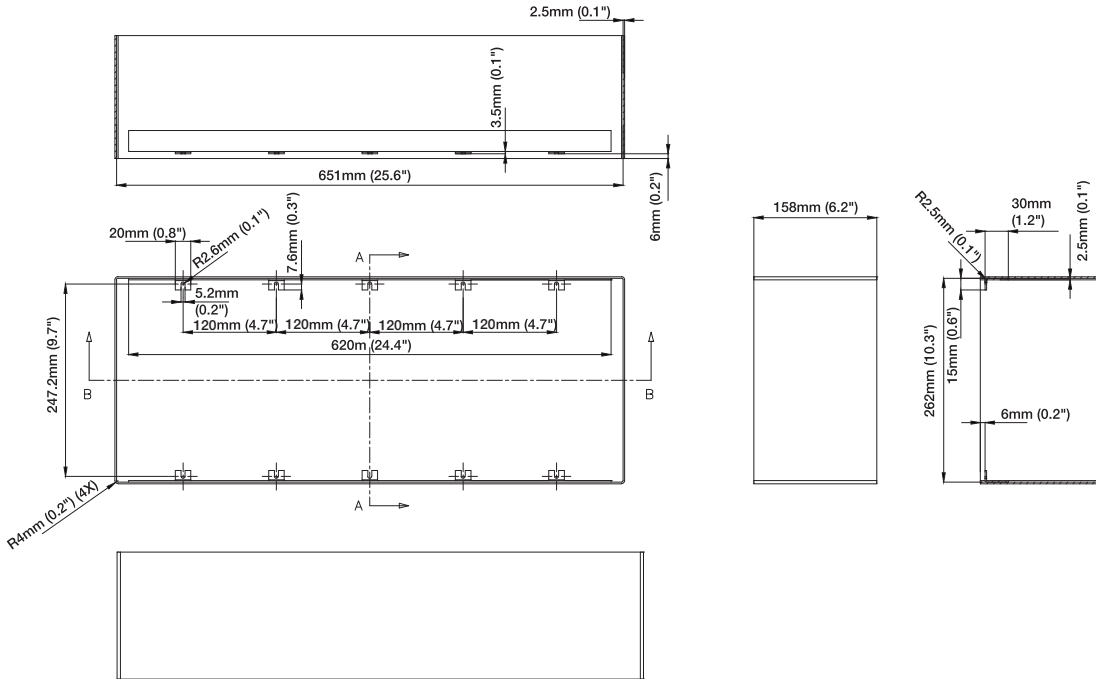

Half Glare Shield

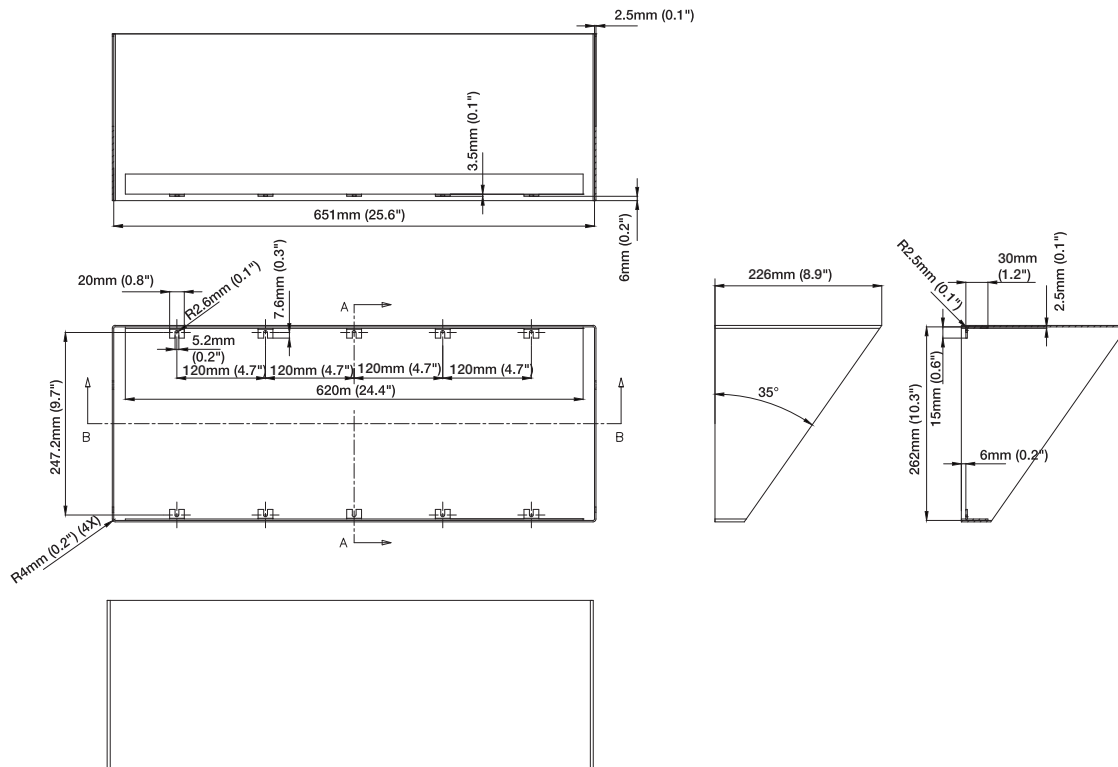

Pole-Mounting Supporter

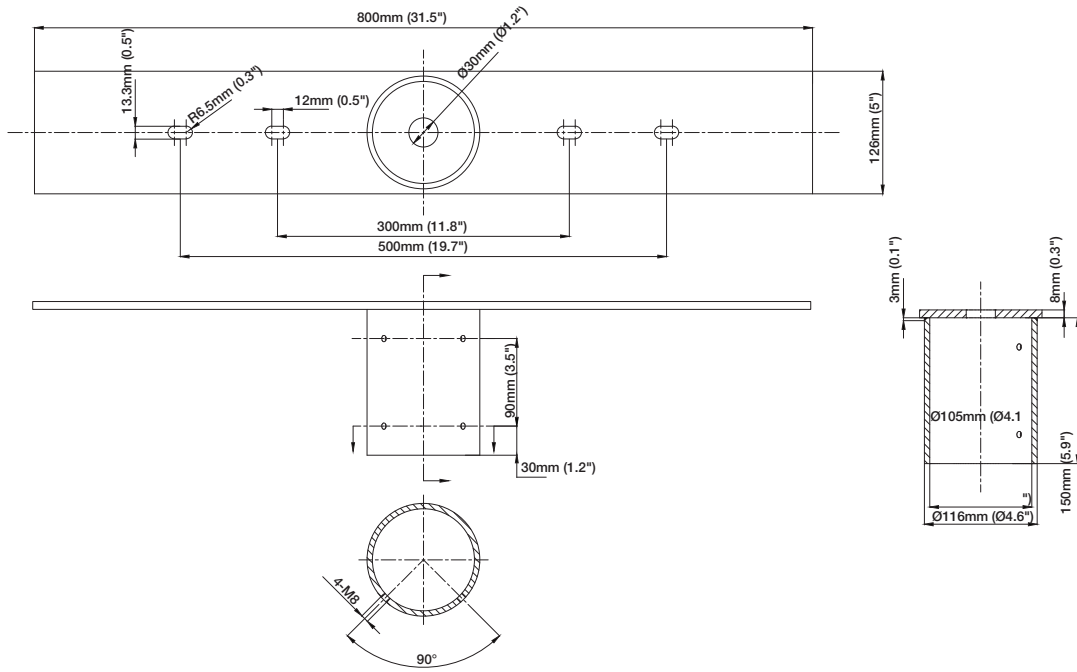

Rock Guard

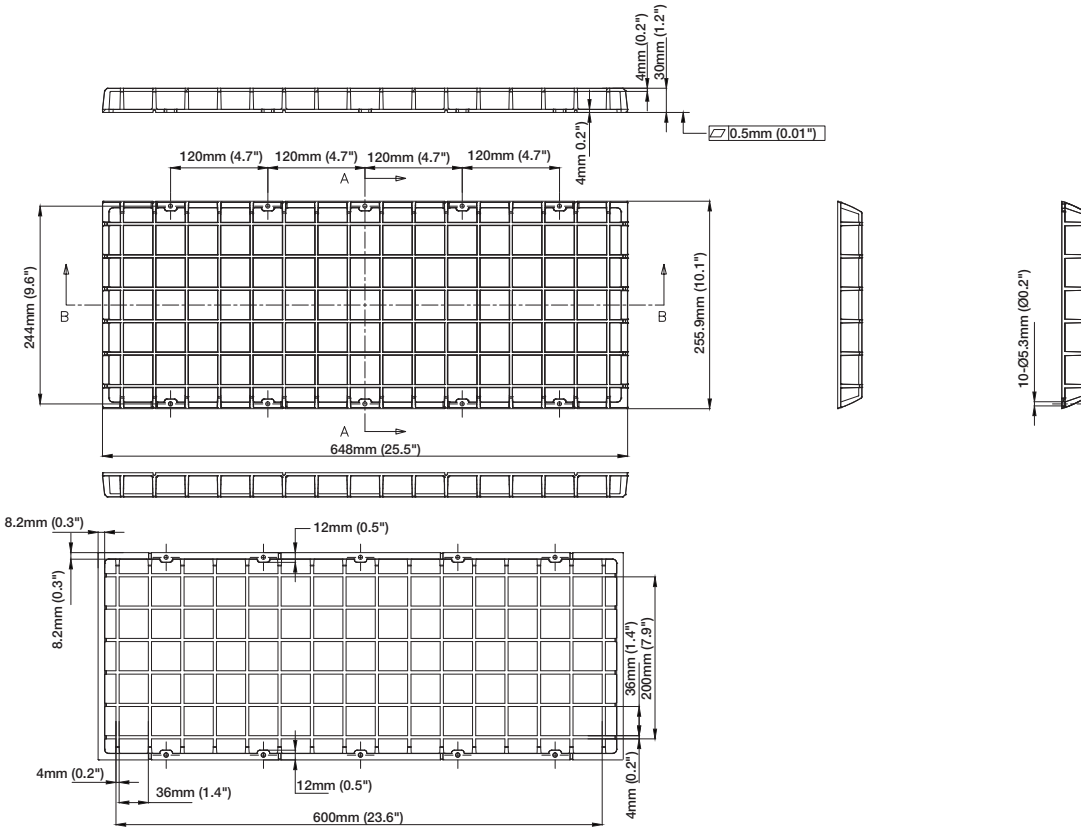

Spread Lens Frame

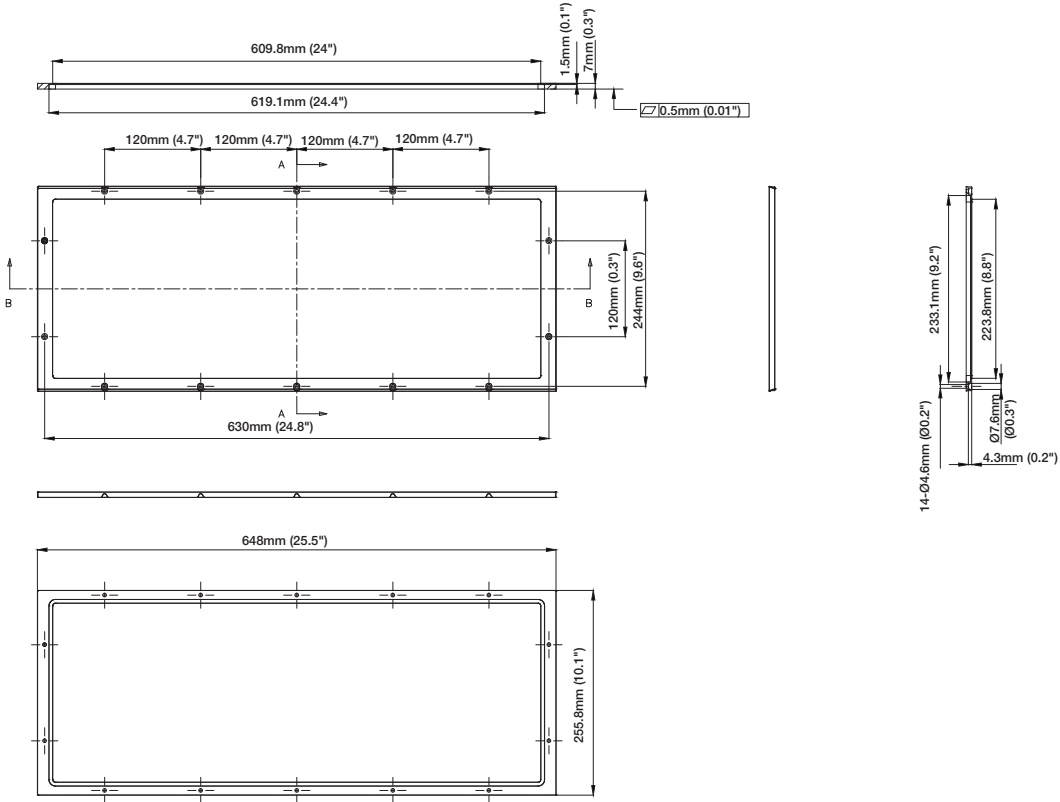

- Vista Plus fixtures ship with two cable whips: One cable whip for power input, consisting of two wires plus a ground, and one cable whip for DMX512 RDM input/output.
- No more than (32) fixtures on a single DMX512 link, max 300m total (source to last fixture).
- Data cabling from DMX source to first fixture and between subsequent Vista Plus fixtures shall be Cat5e UTP or higher (stranded type only) or other cable type suitable for DMX communication. Consult DMX standard for additional guidance.

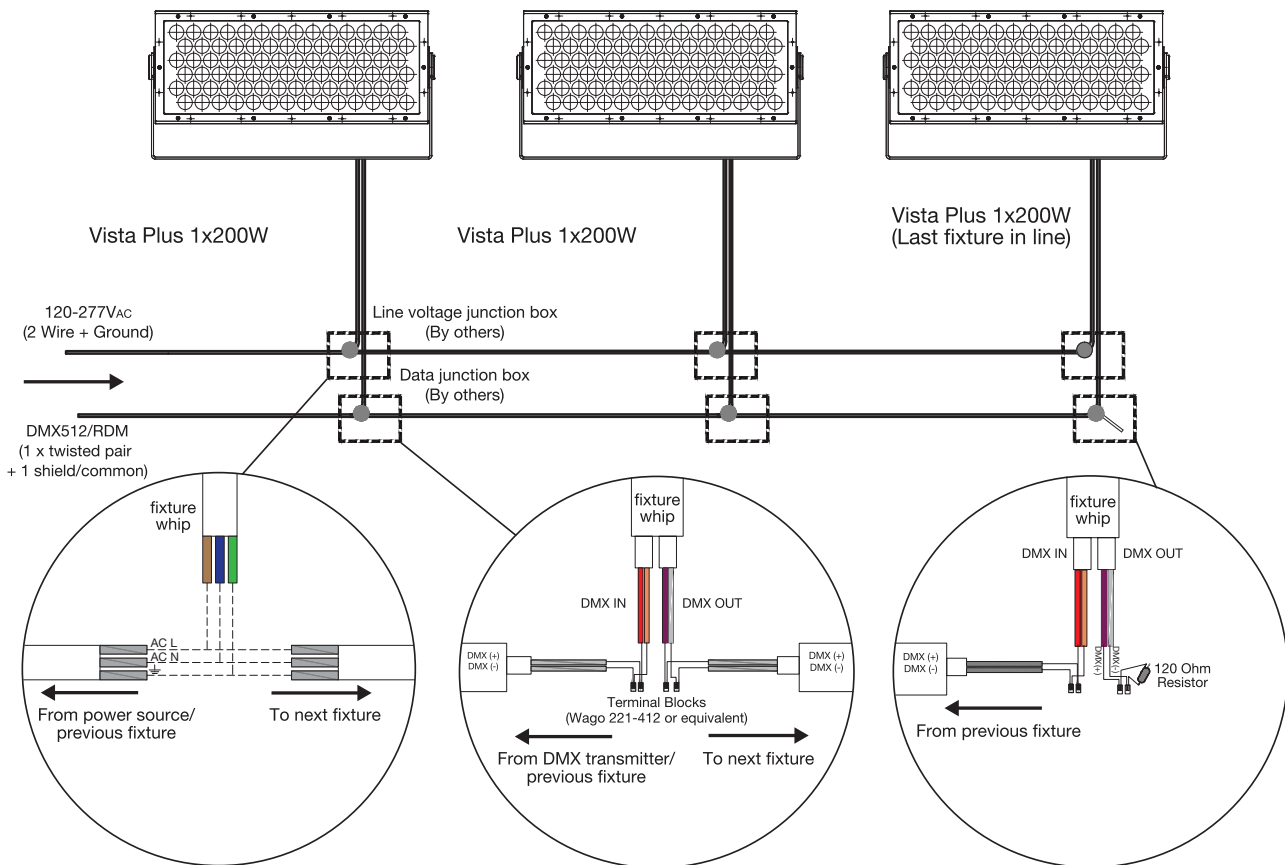

- Each DMX512 link must be properly terminated to prevent signal reflections.

General Notes

- All data cabling must adhere to ANSI E1.11-2008 (R2013) – Entertainment Technology – USITT DMX512-A, Asynchronous Serial Digital Data Transmission Standard for Controlling Lighting Equipment and Accessories.
- Fixture is RDM compatible.
- Fixtures allow a universal input of 100VAC to 277VAC.
- Data termination shall utilize cage clamp terminal blocks, or equivalent. Wire nuts are not permissible and will void warranty.
- The method of line voltage termination, both for data and power, is at the discretion of the installing contractor, and/or engineer. Splicing and/or joining of cables must adhere to all applicable electrical codes.
- Cables must be spliced/joined in a weatherproof enclosure/junction box, which is to be properly rated and provided by others.



Vista Plus 1x200W RGBW

Ordering

Model Number (Fixtures)

PP	V2	9	4	4	1	1	X
	Vista Plus	Control	Color	CCT		Optic	Finish
	V2: Vista Plus 1x200W	9: DMX	4: RGBW	4: 4000K		1: 3°	1: Gray
							2: Black
							3: White

Model Number (Accessories)

PP	VA	0	X	X	0	0	X
	Vista Plus Accessories	Vista Plus Size	Accessory Type	Spread Lens Package			Finish
		0: 1x200W/2x200W	1: Anti-Glare Half Shield	0: n/a			1: Gray
			2: Anti-Glare Full Shield	1: 5°			2: Black
			3: Rockguard	2: 8°			3: White
			4: Spread Lens Module	3: 10°			
			5: Pole-Mounting Support	4: 15°			
				5: 20°			
				6: 30°			
				7: 40°			
				8: 55°			
				9: 80°			
				A: 50° x 10°			
				B: 50° x 5°			

Fixtures

Model No.	Description	Item Code
PP.V2.944111	VISTA PLUS 1x200W RGBW 3° GRAY	AM380310055
PP.V2.944112	VISTA PLUS 1x200W RGBW 3° BLACK	AM380320055
PP.V2.944113	VISTA PLUS 1x200W RGBW 3° WHITE	AM380330055



www.traxon-ecue.com

©2023 TRAXON TECHNOLOGIES – ALL RIGHTS RESERVED. TRAXON™, TX CONNECT®, ARE TRADEMARKS OF TRAXON TECHNOLOGIES. U.S. PATENTS, E.U. PATENTS, JAPAN PATENTS, OTHER PATENTS PENDING. SPECIFICATIONS ARE SUBJECT TO CHANGE WITHOUT NOTICE.

Accessories

Model No.	Description	Item Code
AM243520054	PROPOINT TERMINATION KIT	AM243520054
PP.AK.0000AA	PROPOINT ALLEN KEY SET (3MM – 17MM)	AS000490055
PP.AK.000014	PROPOINT 14MM ALLEN KEY	AS000430055
PP.VA.010001	VISTA PLUS 200W ANTI-GLARE HALF SHIELD	AM380690055
PP.VA.020001	VISTA PLUS 200W ANTI-GLARE FULL SHIELD	AM380720055
PP.VA.030001	VISTA PLUS 200W ROCK GUARD	AM380730055
PP.VA.050001	VISTA PLUS POLE-MOUNTING SUPPORT	AM380750055
PP.VA.041001	VISTA PLUS 200W SPREAD MODULE - 5	AM380760055
PP.VA.042001	VISTA PLUS 200W SPREAD MODULE - 8	AM380770055
PP.VA.043001	VISTA PLUS 200W SPREAD MODULE - 10	AM380780055
PP.VA.044001	VISTA PLUS 200W SPREAD MODULE - 15	AM380790055
PP.VA.045001	VISTA PLUS 200W SPREAD MODULE - 20	AM380800055
PP.VA.046001	VISTA PLUS 200W SPREAD MODULE - 30	AM380810055
PP.VA.047001	VISTA PLUS 200W SPREAD MODULE - 40	AM380820055
PP.VA.048001	VISTA PLUS 200W SPREAD MODULE - 55	AM380830055
PP.VA.049001	VISTA PLUS 200W SPREAD MODULE - 80	AM380840055
PP.VA.04A001	VISTA PLUS 200W SPREAD MODULE - 50x10	AM380850055
PP.VA.04B001	VISTA PLUS 200W SPREAD MODULE - 50x5	AM380860055
PP.VA.010002	VISTA PLUS 200W ANTI-GLARE HALF SHIELD BL	AM380870055
PP.VA.020002	VISTA PLUS 200W ANTI-GLARE FULL SHIELD BL	AM380880055
PP.VA.030002	VISTA PLUS 200W ROCK GUARD BL	AM380890055
PP.VA.050002	VISTA PLUS POLE-MOUNTING SUPPORT BL	AM380900055
PP.VA.041002	VISTA PLUS 200W SPREAD MODULE BL - 5	AM380910055
PP.VA.042002	VISTA PLUS 200W SPREAD MODULE BL - 8	AM380920055
PP.VA.043002	VISTA PLUS 200W SPREAD MODULE BL - 10	AM380930055
PP.VA.044002	VISTA PLUS 200W SPREAD MODULE BL - 15	AM380940055
PP.VA.045002	VISTA PLUS 200W SPREAD MODULE BL - 20	AM380950055
PP.VA.046002	VISTA PLUS 200W SPREAD MODULE BL - 30	AM380960055
PP.VA.047002	VISTA PLUS 200W SPREAD MODULE BL - 40	AM380970055
PP.VA.048002	VISTA PLUS 200W SPREAD MODULE BL - 55	AM380980055
PP.VA.049002	VISTA PLUS 200W SPREAD MODULE BL - 80	AM380990055
PP.VA.04A002	VISTA PLUS 200W SPREAD MODULE BL - 50x10	AM381000055
PP.VA.04B002	VISTA PLUS 200W SPREAD MODULE BL - 50x5	AM381010055
PP.VA.010003	VISTA PLUS 200W ANTI-GLARE HALF SHIELD WT	AM381020055
PP.VA.020003	VISTA PLUS 200W ANTI-GLARE FULL SHIELD WT	AM381030055
PP.VA.030003	VISTA PLUS 200W ROCK GUARD WT	AM381040055
PP.VA.050003	VISTA PLUS POLE-MOUNTING SUPPORT WT	AM381050055
PP.VA.041003	VISTA PLUS 200W SPREAD MODULE WT - 5	AM381060055
PP.VA.042003	VISTA PLUS 200W SPREAD MODULE WT - 8	AM381070055
PP.VA.043003	VISTA PLUS 200W SPREAD MODULE WT - 10	AM381080055
PP.VA.044003	VISTA PLUS 200W SPREAD MODULE WT - 15	AM381090055
PP.VA.045003	VISTA PLUS 200W SPREAD MODULE WT - 20	AM381100055

Accessories

Model No.	Description	Item Code
PP.VA.046003	VISTA PLUS 200W SPREAD MODULE WT - 30	AM381110055
PP.VA.047003	VISTA PLUS 200W SPREAD MODULE WT - 40	AM381120055
PP.VA.048003	VISTA PLUS 200W SPREAD MODULE WT - 55	AM381130055
PP.VA.049003	VISTA PLUS 200W SPREAD MODULE WT - 80	AM381140055
PP.VA.04A003	VISTA PLUS 200W SPREAD MODULE WT - 50x10	AM381150055
PP.VA.04B003	VISTA PLUS 200W SPREAD MODULE WT - 50x5	AM381160055