

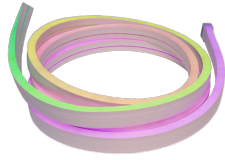

Project: _____

Type: _____

Media Pixel Ribbon RGBW HB Outdoor



The Traxon Media Pixel Ribbon HB is an IP67 flexible neon strip which can be controlled directly using DMX512. The horizontal bending (HB), together with the vertical bending (VB) Ribbon provides flexibility to fit on any curved surface to accommodate architectural structures. Featuring a 0.66" / 16.7 mm LED pitch with a 3.9" / 100 mm pixel pitch, the Media Pixel Ribbon is available in an assortment of colors and CCT options, has multiple mounting options to meet project needs, and is able to be customized for number of pixels, ribbon lengths, and cable feed position.



IK08

Product Specifications

Models	RGB+W (W: 6500K)
Light Source	High intensity SMT RGB and White LEDs
Color Range	16.7 Million additive RGB colors + White
Pixels	61 pixels per roll 3 pixels per ft / 10 pixels per m ¹
LED pitch	0.66" / 16.7 mm
Pixel Pitch	3.9" / 100 mm
Cutting Pitch	3.9" / 100 mm
CRI for White LED	> 80
SDCM for White LED	3-steps
Luminous Flux	47 lm per ft / 157 lm per m
Efficacy	11 lm/W
Beam Angle	120°
Housing	UV resistant diffused silicone
Dimensions (W x H)	0.4" x 0.5" / 10 mm x 12 mm
Max. length	20' / 6.1m per roll
Weight (per roll)	3.4 lb / 1540 g
Mounting	Various mounting brackets and channels
Min. Bend Radius	5.9" / 150 mm
Regulatory Listing & Safety Approval	cETLus, FCC, RoHS, REACH; IK08
Operating Temperature	-4°F to 122°F / -20°C to +50°C
Storage Temperature	-40°F to 158°F / -40°C to +70°C
Environment	IP67 Outdoor Rated; suitable for coastal environments
Humidity	0 to 90% non-condensing

Electrical Specifications

Input Voltage	24V DC
Power Consumption (Typ.)	4.4 W per foot / 14.4 W per meter

System Specifications

Control	DMX512
Power Supply	100W 24V DC Outdoor
Addressing Options	Manual Addressing with 3rd party addressing device

1. Pixel per meter can be customized to 5 pixels, 2 pixels or 1 pixel.

Please consult regional sales office for more information, pricing and lead time.

LED CHARACTERISTICS Because LEDs are semiconductor devices, their performances are subject to inherent variability commonly found in semiconductor industry. To improve consistency in performance across the same product, LED manufacturers "sort" LEDs into bins according to different preset parameters, such as forward driving voltage, illumination, etc. Whereas binning is a sorting function, it is not a correction process. Inherent variability in the manufacturing process results always in different binning distributions according to different production lots. Traxon uses automatically binned LEDs on its products, thereby minimizing output variations within the model range.

As with all electronic devices, LED output degrades over time – a term called lumen depreciation. This also explains why it is nearly impossible to expect photometric performances of two LED products with different service life spans to be the same. The rate of LED degrade is a complicate function of many factors such as operating efficiency, duration of continuous operation, and more significantly, environmental conditions (ambient temperature for example). If allowed working under optimal operating temperature range and with good ventilation, LED devices enjoy long service lives over conventional light sources. When using/installing LED devices, care should be taken to ensure that the devices will operate within the operating conditions specified in respective product literature.

Lumen measurement complies with LM-79-08 standard.
Lumen maintenance is calculated based on LM-80 compliant measurement.



www.traxon-ecue.com

©2023 TRAXON TECHNOLOGIES - AN OSRAM BUSINESS. ALL RIGHTS RESERVED. TRAXON™, TX CONNECT®, ARE TRADEMARKS OF TRAXON TECHNOLOGIES. U.S. PATENTS, E.U. PATENTS, JAPAN PATENTS, OTHER PATENTS PENDING. SPECIFICATIONS ARE SUBJECT TO CHANGE WITHOUT NOTICE.

Source Specifications

LED Source	High intensity SMT RGB and White LEDs
------------	---------------------------------------

Candela Distribution

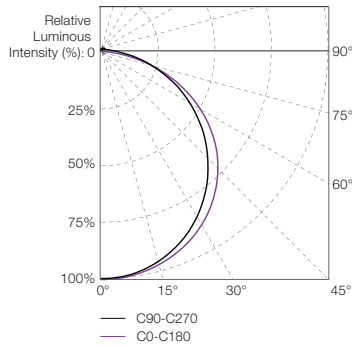

Light Output

Color	Luminous Flux per ft (lm)	Center Intensity (cd)	Efficacy (lm/W)
RGB+W			
RGB+W (full-on)	47	51	11
RGB	24	26	7
Red	5	6	4
Green	16	17	10
Blue	4	5	3
White (RGB off)	24	26	15

Illuminance at a Distance

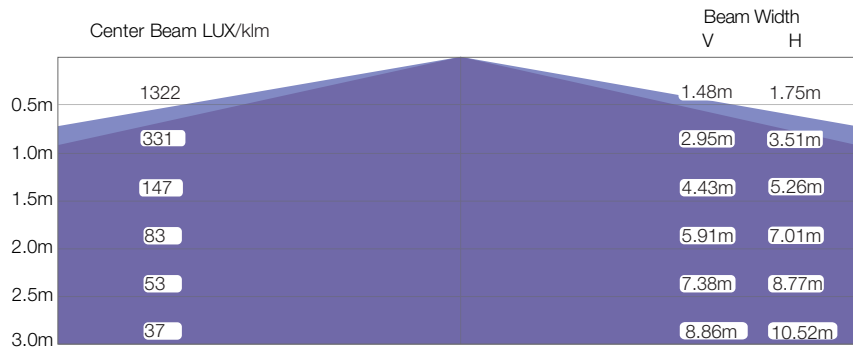

For feet multiply by 3.28

- Vert. Spread: 111.8°
- Horiz. Spread: 120.6°
- For fc divide by 10.7

IES and LDT files are available for download from the Traxon website.

Media Pixel Ribbon

End cable feed (H1)

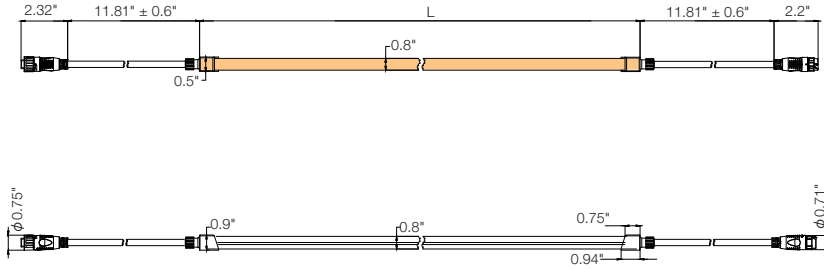

Left side cable feed (H2L)

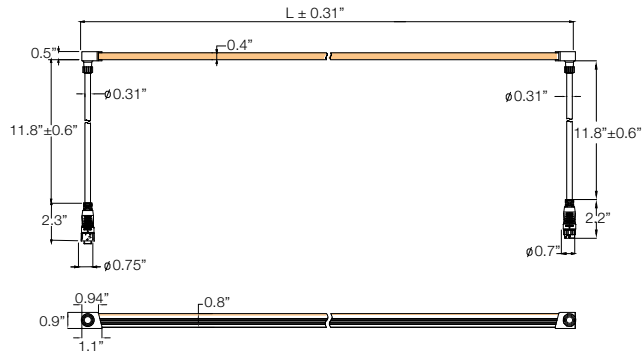

Right side cable feed (H2R)

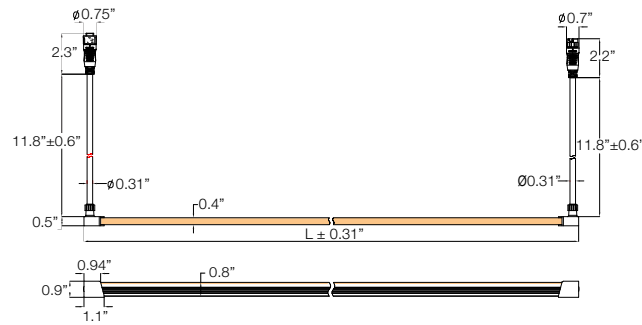

Bottom cable feed (H3)

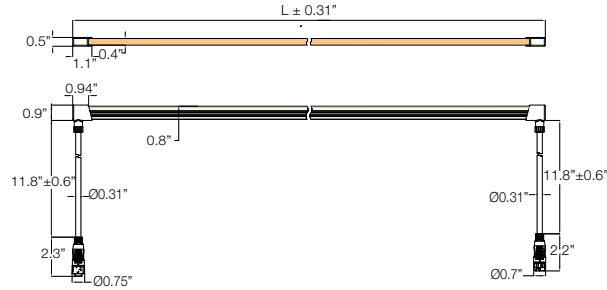

Model	Max. Ribbon length with single power feed	Actual product length with endcap at 2-ends, L
RGB+W & RGB	20' / 6.1m	20'+0.8' / 6.1m+20mm

Remark: For other customized lengths (in multiples of 4" / 100 mm), the actual product length would be customized length + 0.8" / + 20mm.

Connection Accessories

RB CONNECTOR ENDCAP 120OHMP67 (AM400870055)

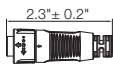

RB 5PIN STARTER CABLE 1M IP67 (AM400840055)
RB 5PIN STARTER CABLE 3M IP67 (AM400850055)

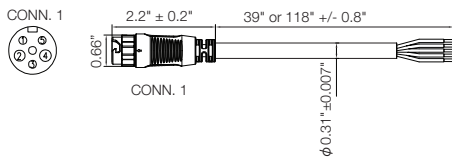

Wire#	Description	Color
1	Address(P)	Green
2	V-	Black
3	DMX+	Yellow
4	V+	Red
5	DMX-	Blue

RB RJ45 STARTER Y-CABLE IP67 (AM401000055)

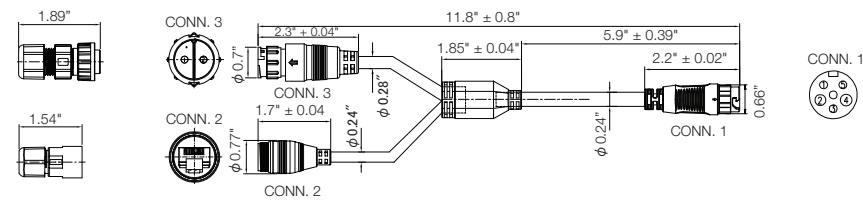

RB 5PIN POWER INJ Y-CABLE IP67 (AM400990055)

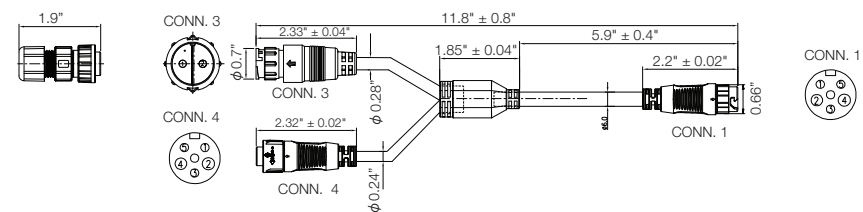

Mounting Accessories

Aluminium U-channel
U-CHANNEL OUTDOOR HB 950 (AM400980055)

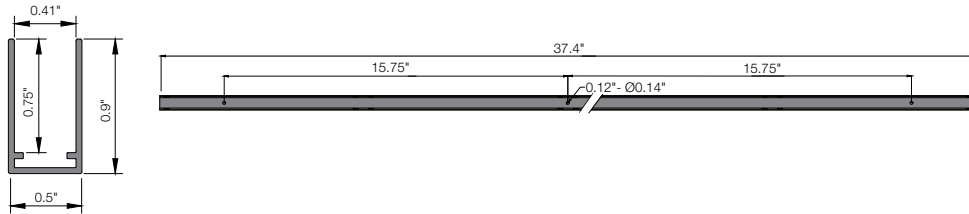

304 Stainless Steel Flexible Strip
FLEXIBLE MOUNT STRIP HB 5M / ROLL (AM400940055)

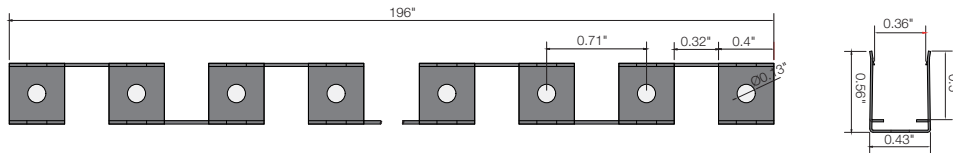

SINGLE MOUNT BRACKET HB (AM400960055)

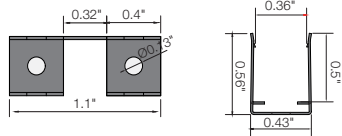

Typical Wiring with 5-pin Starter Cable

NOTE: Mounting accessories not shown.

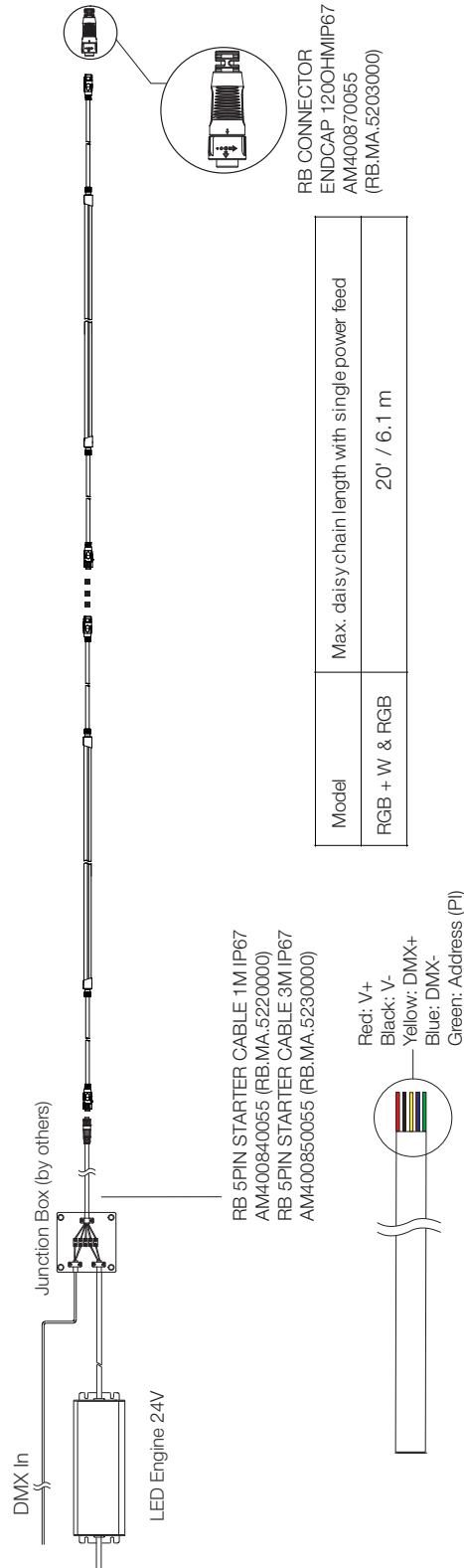

Typical Power Injection with Wiring Y-Cable

NOTE: Mounting accessories not shown.

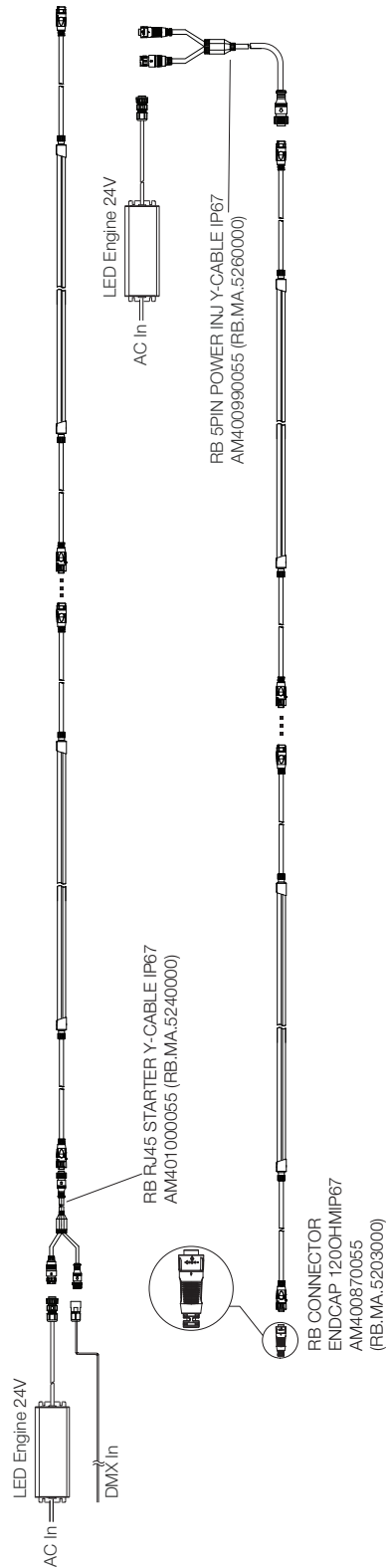

Power injection is required when ribbon connection length reaches the maximum length with single power feed.

Fixtures

Model No.	Description	Item Code
RB.UO.6140200	PX RB RGBW65 61PPR 20FT DX H1 IP67 ETL (END CABLE FEED)	AM433760055
RB.UO.6140220	PX RB RGBW65 61PPR 20FT DX H2L IP67 ETL (SIDE CABLE FEED LEFT)	AM433830055
RB.UO.6140290	PX RB RGBW65 61PPR 20FT DX H2R IP67 ETL (SIDE CABLE FEED RIGHT)	AM433900055
RB.UO.6140230	PX RB RGBW65 61PPR 20FT DX H3 IP67 ETL (BOTTOM CABLE FEED)	AM433970055

TX Connect

Model No.	Description	Item Code
RB.MA.5220000	RB 5PIN STARTER CABLE 1M IP67	AM400840055
RB.MA.5230000	RB 5PIN STARTER CABLE 3M IP67	AM400850055
RB.MA.5270000	RB 5PIN STARTER CABLE 5M IP67	AM415500055
RB.MA.5260000	RB 5PIN POWER INJ Y-CABLE IP67	AM400990055
RB.MA.5240000	RB RJ45 STARTER Y-CABLE IP67	AM401000055
N/A	RB CONNECTOR ENDCAP IP67	AM400860055
RB.MA.5203000	RB CONNECTOR ENDCAP 120OHM IP67	AM400870055

TX Cutting tools

Model No.	Description	Item Code
N/A	PX RIBBON CUTTING TOOL	AM412950055
N/A	PX RIBBON SEALING GLUE 100ML	AM412960055
N/A	RX RIBBON HB FIELD CUT ENDCAP 20PC	AM412980055

TX Mounting

Model No.	Description	Item Code
N/A	FLEXIBLE MOUNT STRIP HB 5M	AM400940055
N/A	SINGLE MOUNT BRACKET HB 20PC	AM400960055
N/A	U-CHANNEL OUTDOOR HB 950	AM400980055

TX Power Supply

Model No.	Description	Item Code
N/A	LED ENGINE 100W 24V OUTDOOR	AM175860055

Addressing Device

Please contact your sales representative for details.